

GADERFORM

Gaderform Möbel GmbH
Zwischenwasser 4
I-39030 Enneberg
Tel: 0039 0474 501 178

Gaderform mobili srl
Longega 4
39030 Marebbe
tel: 0474 501 178

info@gaderform.com
www.gaderform.com



Preisliste | Listino prezzi 21-22

living **NATURE.**



GADERFORM



Starke Wurzeln im Gadertal
Ben radicati in Val Badia



Die Natur ist unser Lehrmeister
La natura è la nostra maestra



Holz ist ein natürlicher Baustoff
Legno, un materiale naturale



Aus Südtirol für die ganze Welt
Dall'Alto Adige per tutto il mondo

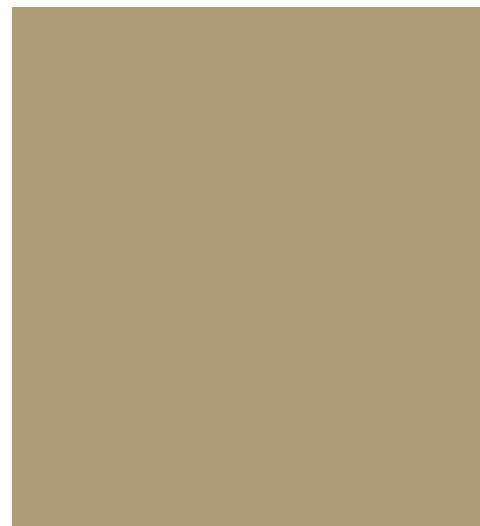

living **NATURE.**

Wir lieben Holz! Deshalb verarbeiten wir es mit höchster Sorgfalt: in bester Handwerksqualität, die Generationen überdauert. Seit über 40 Jahren formen wir daraus massive Vollholzmöbel, beständig und zeitlos schön, für ein gesundes Wohnen inmitten der Natur.

Amiamo il legno! Ecco perché lo lavoriamo con la massima cura: la migliore qualità artigiana che sopravvive alle generazioni. Da oltre 40 anni diamo vita a mobili in legno massello, resistenti, dall'intramontabile bellezza e naturalmente privi di sostanze nocive, affinché possiate vivere in un ambiente a contatto con la natura.



Maßanfertigung & Großaufträge
Ordini su misura e grossi ordinativi



HOLZARTEN

tipologie del legno



EO

Eiche (Asteiche) mit Öl behandelt
rovere trattato con l'olio



NO

Nuss (amerikanisch) mit Öl behandelt
noce (americano) trattato con l'olio



BU

Buche (Kernbuche) mit Wasserlack behandelt
faggio con vernice all'acqua



BN

Buche Nuss-gebeizt mit Wasserlack behandelt
faggio tinto noce e verniciato



ZR

Zirbe (Arve) roh unbehandelt
cirmolo grezzo non trattato



ZO

Zirbe (Arve) mit Öl behandelt
cirmolo trattato con l'olio



F

Fichte mit Wasserlack behandelt
abete con vernice all'acqua



FR

Fichte roh unbehandelt
abete grezzo non trattato



FS

Fichte gebürstet und mit Wasserlack behandelt
abete spazzolato e verniciato



FO

Fichte mit Öl behandelt
abete trattato con l'olio



FN

Fichte gebürstet, weiß lackiert (Wasserlack)
abete spazzolato, verniciato a bianco



AF

Altholz gebürstet
legno vecchio, spazzolato

Schränke schaffen Ordnung! Wählen Sie aus einer Vielfalt an Modellen in jeglicher Ausführung. Schranktüren und Korpus aus Massivholz. Rückwände aus Sperrholz. Scharniere mit integrierter Türbremse.
[Konfigurationsmöglichkeit auf www.gaderform.com](http://www.gaderform.com)

Grande varietà di armadi in legno naturale. Porte e struttura-armadio in legno massiccio. Schienali in multistrato. Cerniere con ammortizzatore integrato. Mobili su misura da configurare su www.gaderform.com

Schubladenauszüge mit Einzugsdämpfung
guide per cassetti con chiusura rallentata

Keines unserer Betten ist wie das andere. Aber alle sind aus hochwertigem Massivholz und auf Wunsch auch einige metallfrei gefertigt.
[Konfigurationsmöglichkeit auf www.gaderform.com](http://www.gaderform.com)

I nostri letti sono tutti diversi, eppure tutti realizzati in pregiato legno massello. A richiesta, anche privi di parti metalliche. Mobili su misura da configurare su www.gaderform.com



Schlafen - zona notte

GARDENA	08 - 11
ELBA	12 - 13
CORTINA	14 - 19
AMSTERDAM	20 - 25
NEW YORK	26 - 29
GINEVRA	30 - 31



10



08



12



18



26

metallfreie Betten
esente da parti metalliche

NATURA	32 - 35
GARDENA	36 - 37
ALPINA	38 - 39
FANES	40 - 41



32



34



38



46



48

INNSBRUCK	42 - 43
NIZZA	44 - 45
LUGANO	46 - 47
CASTELLO	48 - 49
COLONIA	50 - 51

Schränke - armadi

CORTINA	52 - 53
GARDA	54 - 55
AMSTERDAM	56 - 57
MERANO	58 - 59



54



52

Wohnen - zona giorno

COLONIA	60 - 61
BASILEA	62 - 65
VIENNA	66 - 67



60



62

Essen - zona pranzo

DOLOMIT	68 - 69
COLONIA	70 - 71
VIENNA	72 - 73
BASILEA	74 - 75



72



68

Übersicht Betten - riepilogativo letti	76 - 77
Übersicht Schränke - riepilogativo armadi	78 - 79
Verkaufsbedingungen - condizioni di vendita	80 - 81
Bestellformular - modulo di ordinazione	82
Sonderanfertigungen - lavori su misura	83



Fichte (Astfichte) abete
F mit Wasserlack behandelt con vernice all'acqua
FR roh unbehandelt grezzo non trattato
FS gebürstet und lackiert spazzolato e verniciato
FO mit Öl behandelt trattato con l'olio
FN gebürstet, weiß lackiert spazzolato, verniciato a bianco

Buche (Kernbuche) faggio
BU mit Wasserlack behandelt con vernice all'acqua
BN "Nuss" gebeizt und lackiert tinto noce e verniciato
Nuss (amerikanisch) noce americano
NO mit Öl behandelt trattato con l'olio

Eiche (Asteiche) rovere
EO mit Öl behandelt trattato con l'olio

Zirbe Arve cirmolo
ZR roh unbehandelt grezzo non trattato
ZO mit Öl behandelt trattato con l'olio

Griffart tipo maniglia
9900
 Griffleiste aus Holz listello maniglia in legno

<p>A: 48 cm B: 18 cm C: 30 cm</p>													
	Innenmaß cm misura interna cm	90 x 200	100 x 200	140 x 200	180 x 200	200 x 200	Nachtkästchen comodo		Nachtkästchen comodo		Nachtisch metallfrei comodo		
Art.	8290	8300	8340	8380	8400	8048	8043	7403					
BxHxT - LxAxP cm	97 x 101 x 209	107 x 101 x 209	147 x 101 x 209	187 x 101 x 209	207 x 101 x 209	61 x 48 x 41	72 x 45 x 41	60 x 48 x 37					
Colli / kg	2 / 44	2 / 47	2 / 57	2 (3) / 65	2 (3) / 70	1 / 17	1 / 14	1 / 17					
HOLZART - tipologia del legno													
Fichte - abete €													
Buche - faggio €													
Eiche - rovere €													
Zirbe - cirmolo €													
Nuss - noce €													

<p>A: 48 cm B: 18 cm C: 30 cm</p>													
	Innenmaß cm misura interna cm	90 x 200	100 x 200	140 x 200	180 x 200	200 x 200	Wand- oder Seitenablage mensola comodo		Kommode cassetiera		Kommode cassetiera		
Art.	8295	8305	8345	8385	8405	8047	8059	8064					
BxHxT - LxAxP cm	97 x 101 x 209	107 x 101 x 209	147 x 101 x 209	187 x 101 x 209	207 x 101 x 209	40 x 12 x 32	118 x 64 x 41	105 x 82 x 51					
Colli / kg	2 / 44	2 / 47	3 / 57	3 / 65	3 / 70	1 / 6	2 / 31	1 / 40					
HOLZART - tipologia del legno													
Fichte - abete €													
Buche - faggio €													
Eiche - rovere €													
Zirbe - cirmolo €													
Nuss - noce €													

	Systemschrank armadio componibile													
Maßänderung und Konfigurationsmöglichkeit auf www.gaderform.com armadi su misura da configurare su www.gaderform.com														
Art.	8001	8002	8005	8006	8024	8016	8023	8013						
BxHxT - LxAxP cm	53 x 226 x 58	53 x 226 x 58	105 x 226 x 58	105 x 226 x 58	105 x 89 x 58	105 x 38 x 58	105 x 99 x 58	___ x 8 x 3						
Colli / kg	2 (3) / 46	2 (3) / 46	3 / 68	3 / 80	2 / 46	1 / 28	1 (2) / 39	1 / 2						
HOLZART - tipologia del legno														
Fichte - abete €														
Buche - faggio €														
Eiche - rovere €														
Zirbe - cirmolo €														
Nuss - noce €														



**Trennbare Doppelbett
letto doppio separabile**

Bett links 90x200
letto sx 90x200 Bett rechts 90x200
letto dx 90x200

***Maß für Lattenrost
*misura per rete
Innenmaß cm
misura interna cm**

A: 48 / 45 cm
B: 18 / 15 cm
C: 30 cm

Kopftäfelung
testata letto Kopftäfelung
testata letto

180 x 200 180 x 200 *89 x 200 cm

Oberkante Bettseiten 45 cm, Einlegetiefe 15 cm
altezza giroletto 45 cm

Art.	8307	8309	8381	8382	8346	8347
BxHxT - LxAxP cm	220 x 100 x 5,5	220 x 150 x 5,5	187 x 48 x 206	187 x 45 x 206	94 x 45 x 206	94 x 45 x 206
Colli / kg	2 / 36	3 / 54	2 / 58	2 / 58	2 / 42	2 / 42

HOLZART - tipologia del legno

Fichte - abete €						
Buche - faggio €						
Eiche - rovere €						
Zirbe - cirmolo €						

Täfelung mit Druck auf Holzpaneel
(Fotoauswahl nach Kundenwunsch)
testata con stampa sul legno
(foto a scelta del cliente)

Täfelung mit 2 gepolsterten
Lodenstoffpaneelen
testata con 2 pannelli imbottiti,
foderati con "Loden"

Nachtkästchen
comodino Nachtkästchen
comodino Nachttisch
comodino Nachttisch-Hocker
sgabello

50 cm 100 cm

Art.	8311	8314	8048	8043	8044	3580
BxHxT - LxAxP cm	220 x 150 x 5,5	220 x 150 x 5,5	61 x 48 x 41	72 x 45 x 41	45 x 45 x 45	45 x 45 x 45
Colli / kg	3 / 54	3 / 54	1 / 17	1 / 14	1 / 14	1 / 8

HOLZART - tipologia del legno

Fichte - abete €						
Buche - faggio €						
Eiche - rovere €						
Zirbe - cirmolo €						

Schränke mit rahmenlosen SCHIEBETÜREN
armadi con ante scorrevoli

Maßänderung und Konfigurationsmöglichkeit auf www.gaderform.com
armadi su misura da configurare su www.gaderform.com

offene Garderobe
guardaroba Kofferbock
portavaligie Zimmertisch
tavolino Stuhl
sedia

Art.	3720	3722	3630	3635	3607	3600
BxHxT - LxAxP cm	120 x 210 x 65	155 x 231 x 65	45 x 187 x 45	120 x 45 x 45	80 x 76 x 65	40 x 90 x 50
Colli / kg	5 / 82	7 / 110	1 / 32	1 / 26	1 / 20	1 / 7

HOLZART - tipologia del legno

Fichte - abete €						
Buche - faggio €						
Eiche - rovere €						
Zirbe - cirmolo €						

Fichte (Astfichte) abete	F mit Wasserlack behandelt con vernice all'acqua	FR roh unbehandelt grezzo non trattato	FS gebürstet und lackiert spazzolato e verniciato	FO mit Öl behandelt trattato con l'olio	FN gebürstet, weiß lackiert spazzolato, verniciato a bianco
Buche (Kernbuche) faggio	BU mit Wasserlack behandelt con vernice all'acqua	BN "Nuss" gebeizt und lackiert tinto noce e verniciato			
Eiche (Asteiche) rovere	EO mit Öl behandelt trattato con l'olio				
Zirbe Arve cirmolo	ZR roh unbehandelt grezzo non trattato	ZO mit Öl behandelt trattato con l'olio	Griffart tipo maniglia	9900 Griffleiste aus Holz listello maniglia in legno	

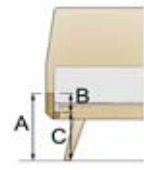
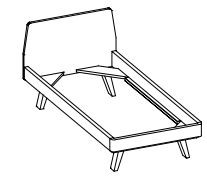
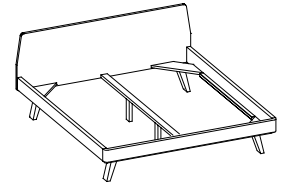
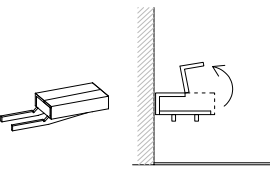

Fichte (Astfichte) abete	F mit Wasserlack behandelt con vernice all'acqua	FR roh unbehandelt grezzo non trattato	FS gebürstet und lackiert spazzolato e verniciato	FO mit Öl behandelt trattato con l'olio	FN gebürstet, weiß lackiert spazzolato, verniciato a bianco
Buche (Kernbuche) faggio	BU mit Wasserlack behandelt con vernice all'acqua	BN "Nuss" gebeizt und lackiert tinto noce e verniciato	Nuss (amerikanisch) noce americano	NO mit Öl behandelt trattato con l'olio	
Eiche (Asteiche) rovere	EO mit Öl behandelt trattato con l'olio				
Zirbe Arve cirmolo	ZR roh unbehandelt grezzo non trattato	ZO mit Öl behandelt trattato con l'olio	Griffart tipo maniglia		Griffausfräsung bei Kommoden maniglia fresata su comò e cassettiere

							
A: 42 cm B: 12 cm C: 30 cm	Einzelbett Einlegetiefe 12 cm letto singolo - giroletto 12 cm	Doppelbett mit Mittelleiste Einlegetiefe 12 cm letto matrimoniale - giroletto 12 cm			Nachtkästchen mit Klappe inkl. Auflageleisten am Bett befestigt comodino con supporti laterali		
Innenmaß cm misura interna cm	90 x 200	100 x 200	140 x 200	160 x 200	180 x 200	200 x 200	
Art.	9090	9100	9140	9160	9180	9200	9020
BxHxT - LxAxP cm	100 x 95 x 208	110 x 95 x 208	150 x 95 x 208	170 x 95 x 208	190 x 95 x 208	210 x 95 x 208	50(+37) x 12 x 30
Colli / kg	3 / 44	3 / 47	3 / 57	3 / 61	3 / 65	3 / 70	1 / 12
HOLZART - tipologia del legno							
Fichte - abete €							
Buche - faggio €							
Eiche - rovere €							
Zirbe - cirmolo €							
Nuss - noce €							

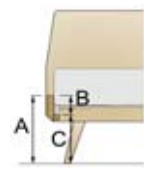
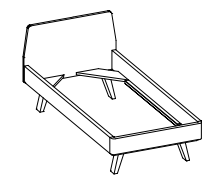
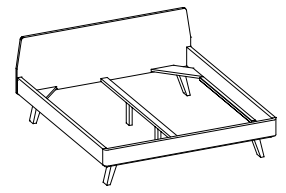
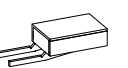
							
A: 47 cm B: 17 cm C: 30 cm	Einzelbett Einlegetiefe 17 cm letto singolo - giroletto 17 cm	Doppelbett mit Mittelleiste Einlegetiefe 17 cm letto matrimoniale - giroletto 17 cm			Nachtkästchen mit Schublade inkl. Auflageleisten am Bett befestigt comodino con cassetto e supporti laterali		
Innenmaß cm misura interna cm	90 x 200	100 x 200	140 x 200	160 x 200	180 x 200	200 x 200	
Art.	9095	9105	9145	9165	9185	9205	9025
BxHxT - LxAxP cm	100 x 95 x 208	110 x 95 x 208	150 x 95 x 208	170 x 95 x 208	190 x 95 x 208	210 x 95 x 208	50(+37) x 17 x 35
Colli / kg	3 / 50	3 / 53	3 / 64	3 / 69	3 / 74	3 / 79	1 / 14
HOLZART - tipologia del legno							
Fichte - abete €							
Buche - faggio €							
Eiche - rovere €							
Zirbe - cirmolo €							
Nuss - noce €							

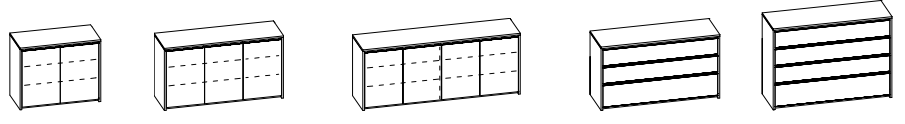
					
Innenmaß cm misura interna cm	Kommoden mit Türen Comò con ante			Schubladen - Kommode cassettiera	
Art.	9042	9043	9044	9053	9054
BxHxT - LxAxP cm	90 x 74 x 46	135 x 74 x 46	180 x 74 x 46	115 x 74 x 46	115 x 95 x 46
Colli / kg	1 / 28	1 / 43	1 / 54	1 / 37	1 / 47
HOLZART - tipologia del legno					
Fichte - abete €					
Buche - faggio €					
Eiche - rovere €					
Zirbe - cirmolo €					
Nuss - noce €					



Fichte (Astfichte) abete
F mit Wasserlack behandelt con vernice all'acqua
FR roh unbehandelt grezzo non trattato
FS gebürstet und lackiert spazzolato e verniciato
FO mit Öl behandelt trattato con l'olio
FN gebürstet, weiß lackiert spazzolato, verniciato a bianco

Buche (Kernbuche) faggio
BU mit Wasserlack behandelt con vernice all'acqua
BN "Nuss" gebeizt und lackiert tinto noce e verniciato

Eiche (Asteiche) rovere
EO mit Öl behandelt trattato con l'olio

Zirbe Arve cirmolo
ZR roh unbehandelt grezzo non trattato
ZO mit Öl behandelt trattato con l'olio

Griffart tipo maniglia
9900
 Griffleiste aus Holz listello maniglia in legno

Maßänderung und Konfigurationsmöglichkeit auf www.gaderform.com
letti su misura da configurare su www.gaderform.com

Innenmaß cm misura interna cm	90 x 200	100 x 200	140 x 200	180 x 200	200 x 200	Nachtkästchen comodino	Nachtkästchen comodino	Nachttisch comodino
Art.	8098	8108	8148	8188	8208	8042	8043	8044
BxHxT - LxAxP cm	98 x 97 x 214	108 x 97 x 214	148 x 97 x 214	188 x 97 x 214	208 x 97 x 214	61 x 45 x 41	72 x 45 x 41	45 x 45 x 45
Colli / kg	2 / 44	2 / 47	2 / 56	2 / 65	2 / 70	1 / 17	1 / 14	1 / 14

HOLZART - tipologia del legno

Fichte - abete €								
Buche - faggio €								
Eiche - rovere €								
Zirbe - cirmolo €								
Nuss - noce €								

Sockelbereich in Buche, Eiche, Zirbe oder Nuss. Kopfteil, Bettrahmen und Korpusse in Fichte gebürstet, weiß lackiert. zoccoli in faggio, rovere, cirmolo o noce. Testata, giroletto e cassettiera in abete spazzolato, verniciato a bianco.

FN / BU €								
FN / EO €								
FN / ZR(ZO) €								
FN / NO €								

Doppelbett mit **Längs-Auflageleisten** (für Motorlattenroste geeignet) letto con listelli d'appoggio longitudinali

Innenmaß cm misura interna cm	180 x 200	200 x 200	Wand- oder Seitenablage mensola comodino	Nachtkästchen comodino	Nachttisch comodino	Unterteil m. Laden base con cassetti	Kommode cassetiera	Kommode cassetiera
Art.	8189	8209	8047	8048	8045	8052	8059	8064
BxHxT - LxAxP cm	188 x 97 x 214	208 x 97 x 214	40 x 12 x 32	61 x 48 x 41	58 x 45 x 35	105 x 45 x 41	118 x 64 x 41	105 x 82 x 51
Colli / kg	2 / 65	2 / 70	1 / 6	1 / 17	1 / 12	1 / 29	2 / 31	1 / 40

HOLZART - tipologia del legno

Fichte - abete €								
Buche - faggio €								
Eiche - rovere €								
Zirbe - cirmolo €								
Nuss - noce €								

Sockelbereich in Buche, Eiche, Zirbe oder Nuss. Kopfteil, Bettrahmen und Korpusse in Fichte gebürstet, weiß lackiert. zoccoli in faggio, rovere, cirmolo o noce. Testata, giroletto e cassettiera in abete spazzolato, verniciato a bianco.

FN / BU €								
FN / EO €								
FN / ZR(ZO) €								
FN / NO €								



Fichte (Astfichte) abete
F mit Wasserlack behandelt con vernice all'acqua
FR roh unbehandelt grezzo non trattato
FS gebürstet und lackiert spazzolato e verniciato
FO mit Öl behandelt trattato con l'olio
FN gebürstet, weiß lackiert spazzolato, verniciato a bianco

Buche (Kernbuche) faggio
BU mit Wasserlack behandelt con vernice all'acqua
BN "Nuss" gebeizt und lackiert tinto noce e verniciato

Eiche (Asteiche) rovere
EO mit Öl behandelt trattato con l'olio

Zirbe Arve cirmolo
ZR roh unbehandelt grezzo non trattato
ZO mit Öl behandelt trattato con l'olio

Griffart tipo maniglia
9900
 Griffleiste aus Holz listello maniglia in legno

Maßänderung und Konfigurationsmöglichkeit auf www.gaderform.com
letti su misura da configurare su www.gaderform.com

 A: 45 cm B: 19 cm C: 26 cm								
	Innenmaß cm misura interna cm	90 x 200	100 x 200	140 x 200	180 x 200	200 x 200	Nachtkästchen comodino	Nachtkästchen comodino
Art.	8098	8108	8148	8188	8208	8042	8043	8044
BxHxT - LxAxP cm	98 x 97 x 214	108 x 97 x 214	148 x 97 x 214	188 x 97 x 214	208 x 97 x 214	61 x 45 x 41	72 x 45 x 41	45 x 45 x 45
Colli / kg	2 / 44	2 / 47	2 / 56	2 / 65	2 / 70	1 / 17	1 / 14	1 / 14

HOLZART - tipologia del legno

Fichte - abete €								
Buche - faggio €								
Eiche - rovere €								
Zirbe - cirmolo €								
Nuss - noce €								

Doppelbett mit Längs-Auflageleisten
 (für Motorlattenroste geeignet)
letto c. listelli d'appoggio longitudinali

 A: 48 cm B: 18 cm C: 30 cm								
	Innenmaß cm misura interna cm	180 x 200	200 x 200	Wand- oder Seitenablage mensola comodino	Hängenachtk. comodino	Hängenachtk. comodino	Nachtkästchen comodino	Kommode cassetiera
Art.	8189	8209	8047	8041	8049	8048	8059	8064
BxHxT - LxAxP cm	188 x 97 x 214	208 x 97 x 214	40 x 12 x 32	61 x 19 x 33	52,5 x 19 x 33	61 x 48 x 41	118 x 64 x 41	105 x 82 x 51
Colli / kg	2 / 65	2 / 70	1 / 6	1 / 11	1 / 8	1 / 17	2 / 31	1 / 40

HOLZART - tipologia del legno

Fichte - abete €								
Buche - faggio €								
Eiche - rovere €								
Zirbe - cirmolo €								
Nuss - noce €								

Systemschrank armadio componibile

Maßänderung und Konfigurationsmöglichkeit auf www.gaderform.com
armadi su misura da configurare su www.gaderform.com

	Innenmaß cm misura interna cm	durchgehender Sockel je LFM zoccolo continuo per metro lineare						
Art.	8001	8002	8005	8006	8024	8016	8023	8013
BxHxT - LxAxP cm	53 x 226 x 58	53 x 226 x 58	105 x 226 x 58	105 x 226 x 58	105 x 89 x 58	105 x 38 x 58	105 x 99 x 58	— x 8 x 3
Colli / kg	2 (3) / 46	2 (3) / 46	3 / 68	3 / 80	2 / 46	1 / 28	1 (2) / 39	1 / 2

HOLZART - tipologia del legno

Fichte - abete €								
Buche - faggio €								
Eiche - rovere €								
Zirbe - cirmolo €								
Nuss - noce €								



	Kopftafelung testata letto		Kopftafelung mit einem gepolsterten Lodenstoffpaneel testata con 1 pann. imbottito (Loden)		Kopftafelung testata letto		Kopftafelung mit 2 gepolsterten Lodenstoffpaneelen testata con 2 pann. imbottiti (Loden)	
Innenmaß cm misura interna cm	für 180er Bett x letto da 180cm	für 200er Bett x letto da 200cm	für 180er Bett x letto da 180cm	für 200er Bett x letto da 200cm	für 180er Bett x letto da 180cm	für 200er Bett x letto da 200cm	für 180er Bett x letto da 180cm	für 200er Bett x letto da 200cm
Art.	8107	8127	8117	8137	8109	8129	8119	8139
BxHxT - LxAxP cm	310 x 97 x 5,5	330 x 97 x 5,5	310 x 97 x 5,5	330 x 97 x 5,5	310 x 146 x 5,5	330 x 146 x 5,5	310 x 146 x 5,5	330 x 146 x 5,5
Colli / kg	2 / 36	2 / 39	2 / 36	2 / 39	3 / 54	3 / 59	3 / 54	3 / 59
HOLZART - tipologia del legno								
Fichte - abete €								
Buche - faggio €								
Eiche - rovere €								
Zirbe - cirmolo €								
Nuss - noce €								
Altholz Fichte - abete vecchio €								

	Kopftafelung mit einem gepolsterten Lodenstoffpaneel testata con 1 pann. imbottito (Loden)		180 x 200		200 x 200		Sockel für Bett zoccolo per letto		Hängenschtk. comodino		Hängenschtk. comodino		Nachtkästchen comodino	
Innenmaß cm misura interna cm	für 180er Bett x letto da 180cm	für 200er Bett x letto da 200cm												
Art.	8118	8138	8181	8182	8199	8041	8049	8044						
BxHxT - LxAxP cm	310 x 146 x 5,5	330 x 146 x 5,5	188 x 45 x 207	208 x 45 x 207	— x 22 x 192	61 x 19 x 33	52,5 x 19 x 33	45 x 45 x 45						
Colli / kg	3 / 54	3 / 59	2 / 58	2 / 32	1 / 15	1 / 11	1 / 8	1 / 14						
HOLZART - tipologia del legno														
Fichte - abete €														
Buche - faggio €														
Eiche - rovere €														
Zirbe - cirmolo €														
Nuss - noce €														
Altholz Fichte - abete vecchio €														

<p>Fichte (Astfichte) abete</p> <p>F mit Wasserlack behandelt con vernice all'acqua</p> <p>FR roh unbehandelt grezzo non trattato</p> <p>FS gebürstet und lackiert spazzolato e verniciato</p> <p>FO mit Öl behandelt trattato con l'olio</p> <p>FN gebürstet, weiß lackiert spazzolato, verniciato a bianco</p>	<p>Buche (Kernbuche) faggio</p> <p>BU mit Wasserlack behandelt con vernice all'acqua</p> <p>BN "Nuss" gebeizt und lackiert tinto noce e verniciato</p>	<p>Nuss (amerikanisch) noce americano</p> <p>NO mit Öl behandelt trattato con l'olio</p>	<p>Altholz legno vecchio</p> <p>AF gebürstet spazzolato</p>	<p>Griffart tipo maniglia</p> <p>9900 Griffleiste aus Holz listello maniglia in legno</p>
<p>Eiche (Asteiche) rovere</p> <p>EO mit Öl behandelt trattato con l'olio</p>	<p>Zirbe Arve cirmolo</p> <p>ZR roh unbehandelt grezzo non trattato</p> <p>ZO mit Öl behandelt trattato con l'olio</p>			

	Doppelbett mit Längs-Auflageleisten (für Motorlattenroste geeignet) letto c. listelli d'appoggio longitudinali		Bett Modell GARDENA letto modello GARDENA				Bett Modell NEW YORK letto modello NEW YORK	
VARIANTEN für Bettrahmen								
VARIANTI per letto								
Innenmaß cm misura interna cm			Höhe Oberkante Bettseite 48 cm altezza giroletto 48 cm	Höhe Oberkante Bettseite 48 cm altezza giroletto 48 cm	Höhe Oberkante Bettseite 45 cm altezza giroletto 45 cm	Höhe Oberkante Bettseite 45 cm altezza giroletto 45 cm	Höhe Oberkante Bettseite 42 cm altezza giroletto 42 cm	Höhe Oberkante Bettseite 42 cm altezza giroletto 42 cm
Art.	8183	8184	8381	8383	8382	8384	7848	7849
BxHxT - LxAxP cm	188 x 48 x 207	208 x 48 x 207	187 x 48 x 206	207 x 48 x 206	187 x 45 x 206	207 x 45 x 206	188 x 42 x 207	208 x 42 x 207
Colli / kg	2 / 58	2 / 61	2 / 58	2 / 61	2 / 58	2 / 61	2 / 52	2 / 55
HOLZART - tipologia del legno								
Fichte - abete €								
Buche - faggio €								
Eiche - rovere €								
Zirbe - cirmolo €								
Nuss - noce €								



<p>Fichte (Astfichte) abete</p> <p>F mit Wasserlack behandelt con vernice all'acqua</p> <p>FR roh unbehandelt grezzo non trattato</p> <p>FS gebürstet und lackiert spazzolato e verniciato</p> <p>FO mit Öl behandelt trattato con l'olio</p> <p>FN gebürstet, weiß lackiert spazzolato, verniciato a bianco</p>	<p>Buche (Kernbuche) faggio</p> <p>BU mit Wasserlack behandelt con vernice all'acqua</p> <p>BN "Nuss" gebeizt und lackiert tinto noce e verniciato</p>	<p>Eiche (Asteiche) rovere</p> <p>EO mit Öl behandelt trattato con l'olio</p>	<p>Zirbe Arve cirmolo</p> <p>ZR roh unbehandelt grezzo non trattato</p> <p>ZO mit Öl behandelt trattato con l'olio</p>	<p>Griffart tipo maniglia</p> <p>Griffausfräsung bei Kommoden maniglia fresata su comò e cassettiere</p>
--	---	---	---	---

A: 38 cm
B: 13 cm
C: 25 cm

Maßänderung und Konfigurationsmöglichkeit auf www.gaderform.com
letti su misura da configurare su www.gaderform.com

Innenmaß cm misura interna cm	Nachtkästchen comodino	Nachtkästchen comodino	90 x 200	100 x 200	140 x 200	160 x 200	180 x 200	200 x 200
Art.	3830	3840	3809	3810	3814	3816	3818	3820
BxHxT - LxAxP cm	58 x 38 x 39	58 x 38 x 39	109 x 92 x 208	119 x 92 x 208	159 x 92 x 208	179 x 92 x 208	199 x 92 x 208	219 x 92 x 208
Colli / kg	1 / 9	1 / 11	2 / 45	2 / 49	2 / 56	2 / 60	2 / 64	2 / 68

Drehtürenschränke mit waagrechter Holzmaserung der Türfüllungen
armadi con ante battenti e venatura del legno orizzontale

Art.	3801	3803	3803 x 2	2052	2099	7853	7854
BxHxT - LxAxP cm	51 x 231 x 58	102 x 231 x 58	204 x 231 x 58	98 x 41 x 50	98 x 2 x 50	102 x 75 x 46	102 x 95 x 46
Colli / kg	3 / 49	3 / 75		1 / 17	1 / 4	1 / 30	1 / 40

HOLZART - tipologia del legno

Fichte - abete €							
Buche - faggio €							
Eiche - rovere €							
Zirbe - cirmolo €							



<p>A: 38 cm B: 13 cm C: 25 cm</p>	<p>Nachtkästchen comodino</p>	<p>Nachtkästchen comodino</p>	<p>90 x 200</p>	<p>100 x 200</p>	<p>140 x 200</p>	<p>160 x 200</p>	<p>180 x 200</p>	<p>200 x 200</p>	
	Art.	3400	3401	3409	3410	3414	3416	3418	3420
BxHxT - LxAxP cm	58 x 38 x 39	58 x 38 x 39	109 x 92 x 208	119 x 92 x 208	159 x 92 x 208	179 x 92 x 208	199 x 92 x 208	209 x 92 x 208	
Colli / kg	1 / 9	1 / 11	2 / 45	2 / 49	2 / 56	2 / 60	2 / 64	2 / 68	
HOLZART - tipologia del legno									
Fichte - abete €									
Buche - faggio €									
Eiche - rovere €									
Zirbe - cirmolo €									

Drehtüreschränke mit waagrecht Holzmaserung der Türfüllungen <i>armadi con ante battenti e venatura del legno orizzontale</i>					
Schrank mit Wäscheeinteilung <i>armadio con divisorio interno</i>				Innenschubladen <i>cassettiera interna</i>	
				1 Fachboden 1 ripiano	
Art.	3302	3306	3303	2052	2099
BxHxT - LxAxP cm	104 x 208 x 58	104 x 208 x 58	153 x 208 x 58	98 x 41 x 50	98 x 2 x 50
Colli / kg	2 (3) / 79	3 / 92	3 (4) / 116	1 / 17	1 / 4
HOLZART - tipologia del legno					
Fichte - abete €					
Buche - faggio €					
Eiche - rovere €					
Zirbe - cirmolo €					

								max. Matratzenhöhe 12 cm alt. mass. materasso 12 cm	
<p>Kommode comò</p>		<p>Kommode cassettiera</p>		<p>Kommode cassettiera</p>		<p>Schreibtisch scrivania</p>		<p>Schreibtisch scrivania</p>	
		<p>Hocker sgabello</p>		<p>Ausziehbett letto estraibile</p>		<p>Bettschublade auf Rollen cassetto estraibile</p>			
Art.	3452	3453	3456	3440	3444	3580	3149	3450	
BxHxT - LxAxP cm	85 x 74 x 41	85 x 74 x 41	127 x 74 x 41	110 x 75 x 56	110 x 75 x 56	45 x 45 x 45	91 x 21 x 199	78 x 20 x 200	
Colli / kg	1 / 30	1 / 33	1 / 38	1 / 23	1 (2) / 38	1 / 8	1 / 18	1 / 18	
HOLZART - tipologia del legno									
Fichte - abete €									
Buche - faggio €									
Eiche - rovere €									
Zirbe - cirmolo €									

<p>Fichte (Astfichte) abete</p> <p>F mit Wasserlack behandelt con vernice all'acqua</p>	<p>FR roh unbehandelt grezzo non trattato</p>	<p>FS gebürstet und lackiert spazzolato e verniciato</p>	<p>FO mit Öl behandelt trattato con l'olio</p>	<p>FN gebürstet, weiß lackiert spazzolato, verniciato a bianco</p>
<p>Buche (Kernbuche) faggio</p> <p>BU mit Wasserlack behandelt con vernice all'acqua</p>	<p>BN "Nuss" gebeizt und lackiert tinto noce e verniciato</p>			
<p>Eiche (Asteiche) rovere</p> <p>EO mit Öl behandelt trattato con l'olio</p>				
<p>Zirbe Arve cirmolo</p> <p>ZR roh unbehandelt grezzo non trattato</p>	<p>ZO mit Öl behandelt trattato con l'olio</p>	<p>Griffart tipo maniglia</p> <p>9900 Griffleiste aus Holz listello maniglia in legno</p>	<p>9903 Metallknopf INOX pomello metallo INOX</p>	



 A: 38 cm B: 13 cm C: 25 cm *Maß für Lattenrost *misura per rete Innenmaß cm misura interna cm						
	Nachtkästchen comodino	Kopftafelung testiera letto	gepolsterte Kopfteil-Auflage inklusive Lodenstoff imbottitura testiera con Loden imbottito	90 x 200	*89 x 200 90 x 200	180 x 200
Art.	3400	3715	3717	3785	3788	3798
BxHxT - LxAxP cm	58 x 38 x 39	205 x 108 x 4	180 x 35 x 3	97 x 38 x 206	94 x 38 x 206	187 x 38 x 206
Colli / kg	1 / 9	1 / 39	1 / 4	2 / 26	2 / 25	2 / 40
HOLZART - tipologia del legno						
Fichte - abete €						
Buche - faggio €						
Eiche - rovere €						
Zirbe - cirmolo €						

 A: 38 cm B: 13 cm C: 25 cm *Maß für Lattenrost *misura per rete Innenmaß cm misura interna cm								
	Nachtkästchen comodino	90 x 200	100 x 200	Wandpaneel mit Einhängebeschlag rivestimento parete con ganci	Bett links letto sinistro *89 x 200 90 x 200	Bett rechts letto destro 180 x 200	200 x 200	
Art.	3401	3786	3787	3738	3789	3790	3799	3800
BxHxT - LxAxP cm	58 x 38 x 39	97 x 79 x 206	107 x 79 x 206	200 x 38 x 2,7	94 x 79 x 206	94 x 79 x 206	187 x 79 x 206	207 x 79 x 206
Colli / kg	1 / 11	2 / 34	2 / 36	1 / 13	2 / 33	2 / 33	2 / 52	2 / 56
HOLZART - tipologia del legno								
Fichte - abete €								
Buche - faggio €								
Eiche - rovere €								
Zirbe - cirmolo €								

 A: 38 cm B: 13 cm C: 25 cm *Maß für Lattenrost *misura per rete Innenmaß cm misura interna cm								
	Schreibtisch scrivania	Hocker sgabello	Regal offen scarpiera	Kofferbock appoggia valigie	Garderobebrett pann. guardaroba	Spiegel+Gard. bitte Spiegel links od. rechts angeben specchio+guard.	Spiegel specchio	Schrank armadio
Art.	3440	3580	3506	3510	3557	3708	3550	3722
BxHxT - LxAxP cm	110 x 75 x 56	45 x 45 x 45	85 x 52 x 35	85 x 73 x 55	85 x 18 x 7	85 x 133 x 8	60 x 86 x 2	155 x 231 x 65
Colli / kg	1 / 23	1 / 8	1 / 14	1 / 18	1 / 3	1 / 17	1 / 5	7 / 110
HOLZART - tipologia del legno								
Fichte - abete €								
Buche - faggio €								
Eiche - rovere €								
Zirbe - cirmolo €								

Fichte (Astfichte) abete	F mit Wasserlack behandelt con vernice all'acqua	FR roh unbehandelt grezzo non trattato	FS gebürstet und lackiert spazzolato e verniciato	FO mit Öl behandelt trattato con l'olio	FN gebürstet, weiß lackiert spazzolato, verniciato a bianco
Buche (Kernbuche) faggio	BU mit Wasserlack behandelt con vernice all'acqua	BN "Nuss" gebeizt und lackiert tinto noce e verniciato			
Eiche (Asteiche) rovere	EO mit Öl behandelt trattato con l'olio				
Zirbe Arve cirmolo	ZR roh unbehandelt grezzo non trattato	ZO mit Öl behandelt trattato con l'olio	Griffart tipo maniglia	9900 Griffleiste aus Holz listello maniglia in legno	9903 Metallknopf INOX pomello metallo INOX



<p>A: 42 cm B: 17 cm C: 25 cm</p>	<p>seitlich an Wand links oder rechts lateralmente a parete, sx o dx</p>						
	Innenmaß cm misura interna cm	180 x 200	200 x 200	Bettschublade auf Rollen cassetto estraibile	90 x 200	Wandpaneel mit Einhängescharnier rivestimento parete con ganci	Hocker sgabello
Art.	7818	7820	7850	7809	3738	3580	8047
BxHxT - LxAxP cm	188 x 88 x 207	208 x 88 x 207	78 x 20 x 130	98 x 88 x 207	200 x 38 x 2,7	45 x 45 x 45	40 x 12 x 32
Colli / kg	2 (3) / 52	2 (3) / 57	1 / 10	2 / 34	1 / 13	1 / 8	1 / 6

HOLZART - tipologia del legno

Fichte - abete €							
Buche - faggio €							
Eiche - rovere €							
Zirbe - cirmolo €							
Nuss - noce €							

<p>11 cm Sockel frontbündig zoccolo a filo frontale</p>	<p>Nachtkästchen comodino Kommode cassetiera Kommode cassetiera Schrank armadio Schrank armadio</p> <p>Info: bei durchgehendem Sockel Info: se con zoccolo continuo</p>					
	Art.	7840	7853	7854	3801	3803
BxHxT - LxAxP cm	53 x 43 x 38	102 x 75 x 46	102 x 95 x 46	51 x 231 x 58	102 x 231 x 58	204 x 231 x 58
Colli / kg	1 / 13	1 / 30	1 / 40	3 / 49	3 / 75	

HOLZART - tipologia del legno

Fichte - abete €							
Buche - faggio €							
Eiche - rovere €							
Zirbe - cirmolo €							
Nuss - noce €							

<p>3 cm Sockel rückversetzt zoccolo rientrante</p>	<p>Nachtkästchen comodino Kommode cassetiera Kommode cassetiera Schrank armadio Schrank armadio</p> <p>1 Fachboden 1 ripiano 1 Fachboden 1 ripiano Innenschubladen cassetiera interna</p>							
	Art.	7940	7953	7954	3901	3903	2046	2099
BxHxT - LxAxP cm	53 x 43 x 38	102 x 75 x 46	102 x 95 x 46	51 x 231 x 58	102 x 231 x 58	47 x 2 x 49	98 x 2 x 50	98 x 41 x 50
Colli / kg	1 / 13	1 / 30	1 / 40	3 / 49	3 / 75	1 / 2	1 / 4	1 / 17

HOLZART - tipologia del legno

Fichte - abete €							
Buche - faggio €							
Eiche - rovere €							
Zirbe - cirmolo €							
Nuss - noce €							

<p>Fichte (Astfichte) abete</p> <p>F mit Wasserlack behandelt con vernice all'acqua</p>	<p>FR roh unbehandelt grezzo non trattato</p>	<p>FS gebürstet und lackiert spazzolato e verniciato</p>	<p>FO mit Öl behandelt trattato con l'olio</p>	<p>FN gebürstet, weiß lackiert spazzolato, verniciato a bianco</p>
<p>Buche (Kernbuche) faggio</p> <p>BU mit Wasserlack behandelt con vernice all'acqua</p>	<p>BN "Nuss" gebeizt und lackiert tinto noce e verniciato</p>	<p>Nuss (amerikanisch) noce americano</p>	<p>NO mit Öl behandelt trattato con l'olio</p>	
<p>Eiche (Asteiche) rovere</p> <p>EO mit Öl behandelt trattato con l'olio</p>				
<p>Zirbe Arve cirmolo</p> <p>ZR roh unbehandelt grezzo non trattato</p>	<p>ZO mit Öl behandelt trattato con l'olio</p>	<p>Griffart tipo maniglia</p> <p></p> <p>Griffausfräsung bei Kommoden maniglia fresata su comò e cassettiere</p>		



<p>A: 42 cm B: 17 cm C: 25 cm</p>								
	<p>Innenmaß cm misura interna cm</p> <p>Nachtkästchen comodino</p> <p>90 x 200 100 x 200 140 x 200 180 x 200 200 x 200 180 x 200 200 x 200</p>							
Art.	7940	7829	7830	7834	7838	7839	7918	7920
BxHxT - LxAxP cm	53 x 43 x 38	98 x 88 x 207	108 x 88 x 207	148 x 88 x 207	188 x 88 x 207	208 x 88 x 207	238 x 115 x 209	238 x 115 x 209
Colli / kg	1 / 13	2 / 40	2 / 44	2 (3) / 52	2 (3) / 58	2 (3) / 64	3 / 70	3 / 74
HOLZART - tipologia del legno								
Fichte - abete €								
Buche - faggio €								
Eiche - rovere €								
Zirbe - cirmolo €								
Nuss - noce €								

<p>A: 42 cm B: 17 cm C: 25 cm</p>	Kopftäfelung testata letto		Kopftäfelung testata letto		Rahmenbett letto con testata bassa						
	für 180er Bett x letto da 180cm		für 200er Bett x letto da 200cm		für 180er Bett x letto da 180cm		für 200er Bett x letto da 200cm		180 x 200	200 x 200	Kommode cassettiera
Art.	8107	8127	8109	8129	7848	7849	7953	7954			
BxHxT - LxAxP cm	310 x 97 x 5,5	330 x 97 x 5,5	310 x 146 x 5,5	330 x 146 x 5,5	188 x 42 x 207	208 x 42 x 207	102 x 75 x 46	102 x 95 x 46			
Colli / kg	2 / 36	2 / 39	3 / 54	3 / 59	2 / 52	2 / 55	1 / 30	1 / 40			
HOLZART - tipologia del legno											
Fichte - abete €											
Buche - faggio €											
Eiche - rovere €											
Zirbe - cirmolo €											
Nuss - noce €											
Altholz Fichte - abete vecchio €											

<p>Fichte (Astfichte) abete</p> <p>F mit Wasserlack behandelt con vernice all'acqua</p> <p>FR roh unbehandelt grezzo non trattato</p> <p>FS gebürstet und lackiert spazzolato e verniciato</p> <p>FO mit Öl behandelt trattato con l'olio</p> <p>FN gebürstet, weiß lackiert spazzolato, verniciato a bianco</p>	<p>Buche (Kernbuche) faggio</p> <p>BU mit Wasserlack behandelt con vernice all'acqua</p> <p>BN "Nuss" gebeizt und lackiert tinto noce e verniciato</p>	<p>Nuss (amerikanisch) noce americano</p> <p>NO mit Öl behandelt trattato con l'olio</p>	<p>Altholz legno vecchio</p> <p>AF gebürstet spazzolato</p>	<p>Griffart tipo maniglia</p> <p>Griffausfräsung bei Kommoden maniglia fresata su comò e cassettiere</p>
<p>Eiche (Asteiche) rovere</p> <p>EO mit Öl behandelt trattato con l'olio</p>	<p>Zirbe Arve cirmolo</p> <p>ZR roh unbehandelt grezzo non trattato</p> <p>ZO mit Öl behandelt trattato con l'olio</p>			

	Schränke mit rückversetztem Sockel inklusive Sockelfüße zur Höhenverstellung armadi con zoccolo rientrante incluso piedini regolatori d'altezza					1 Fachboden 1 ripiano	1 Fachboden 1 ripiano	Innenschubladen cassettiera interna
	Art.	7901	7902	7903	7904	7905	2046	2099
BxHxT - LxAxP cm	51 x 231 x 58	102 x 231 x 58	102 x 231 x 58	102 x 231 x 58	102 x 231 x 58	47 x 2 x 49	98 x 2 x 50	98 x 41 x 50
Colli / kg	3 / 49	3 / 78	3 / 82	3 / 85	3 / 74	1 / 2	1 / 4	1 / 17
HOLZART - tipologia del legno								
Fichte - abete €								
Buche - faggio €								
Eiche - rovere €								
Zirbe - cirmolo €								
Nuss - noce €								



<p>Fichte (Astfichte) abete</p> <p>F mit Wasserlack behandelt con vernice all'acqua</p>	<p>FR roh unbehandelt grezzo non trattato</p>	<p>FS gebürstet und lackiert spazzolato e verniciato</p>	<p>FO mit Öl behandelt trattato con l'olio</p>	<p>FN gebürstet, weiß lackiert spazzolato, verniciato a bianco</p>	
<p>Buche (Kernbuche) faggio</p> <p>BU mit Wasserlack behandelt con vernice all'acqua</p>	<p>BN "Nuss" gebeizt und lackiert tinto noce e verniciato</p>				
<p>Eiche (Asteiche) rovere</p> <p>EO mit Öl behandelt trattato con l'olio</p>					
<p>Zirbe Arve cirmolo</p> <p>ZR roh unbehandelt grezzo non trattato</p>	<p>ZO mit Öl behandelt trattato con l'olio</p>	<p>Griffart tipo maniglia</p> <p>9900 Griffleiste aus Holz listello maniglia in legno</p>	<p>9903 Metallknopf INOX pomello metallo INOX</p>		

 A: 38 cm B: 13 cm C: 25 cm Innenmaß cm misura interna cm	Betten mit geneigtem Kopfteil letti con testata inclinata						Rahmenbetten letti con testata bassa	
	90 x 200	100 x 200	140 x 200	160 x 200	180 x 200	200 x 200	90 x 200	100 x 200
Art.	7098	7108	7148	7168	7188	7208	7091	7101
BxHxT - LxAxP cm	100 x 88 x 221	110 x 88 x 221	150 x 88 x 221	170 x 88 x 221	190 x 88 x 221	210 x 88 x 221	100 x 39 x 212	110 x 39 x 212
Colli / kg	2 / 24	2 / 26	2 / 30	2 / 33	2 / 36	2 / 39	2 / 20	2 / 22
HOLZART - tipologia del legno								
Fichte - abete €								
Buche - faggio €								
Eiche - rovere €								
Zirbe - cirmolo €								

 A: 38 cm B: 13 cm C: 25 cm Innenmaß cm misura interna cm	Betten mit geradem Kopfteil letti con testata dritta						Rahmenbetten letti con testata bassa	
	90 x 200	100 x 200	140 x 200	160 x 200	180 x 200	200 x 200	140 x 200	160 x 200
Art.	7099	7109	7149	7169	7189	7205	7141	7161
BxHxT - LxAxP cm	100 x 88 x 211	110 x 88 x 211	150 x 88 x 211	170 x 88 x 211	190 x 88 x 211	210 x 88 x 211	150 x 39 x 212	170 x 39 x 212
Colli / kg	2 / 24	2 / 26	2 / 30	2 / 33	2 / 36	2 / 39	2 / 26	2 / 29
HOLZART - tipologia del legno								
Fichte - abete €								
Buche - faggio €								
Eiche - rovere €								
Zirbe - cirmolo €								

Innenmaß cm misura interna cm	Maßänderung und Konfigurationsmöglichkeit auf www.gaderform.com armadi su misura da configurare su www.gaderform.com						Rahmenbetten letti con testata bassa	
	50 x 46 x 40	99 x 81 x 46	105 x 206 x 59	105 x 206 x 59	154 x 206 x 59	98 x 41 x 50	180 x 200	200 x 200
Art.	5020	5240	5022	5026	5023	2052	7181	7201
BxHxT - LxAxP cm	50 x 46 x 40	99 x 81 x 46	105 x 206 x 59	105 x 206 x 59	154 x 206 x 59	98 x 41 x 50	190 x 39 x 212	210 x 39 x 212
Colli / kg	1 / 8	1 / 35	2 (3) / 72	3 / 86	3 (4) / 106	1 / 17	2 / 32	2 / 35
HOLZART - tipologia del legno								
Fichte - abete €								
Buche - faggio €								
Eiche - rovere €								
Zirbe - cirmolo €								



<p>Fichte (Astfichte) abete</p> <p>F mit Wasserlack behandelt con vernice all'acqua</p>	<p>FR roh unbehandelt grezzo non trattato</p>	<p>FS gebürstet und lackiert spazzolato e verniciato</p>	<p>FO mit Öl behandelt trattato con l'olio</p>	<p>FN gebürstet, weiß lackiert spazzolato, verniciato a bianco</p>
<p>Buche (Kernbuche) faggio</p> <p>BU mit Wasserlack behandelt con vernice all'acqua</p>	<p>BN "Nuss" gebeizt und lackiert tinto noce e verniciato</p>	<p>Nuss (amerikanisch) noce americano</p> <p>NO mit Öl behandelt trattato con l'olio</p>		
<p>Eiche (Asteiche) rovere</p> <p>EO mit Öl behandelt trattato con l'olio</p>				
<p>Zirbe Arve cirmolo</p> <p>ZR roh unbehandelt grezzo non trattato</p>	<p>ZO mit Öl behandelt trattato con l'olio</p>			

metallfreie Betten mit Komforthöhe <i>esente da parti metalliche e altezza comfort</i>								
	A: 48 cm		B: 18 cm		C: 30 cm			
Innenmaß cm <i>misura interna cm</i>	80 x 200 cm	90 x 200 cm	100 x 200 cm	120 x 200 cm	140 x 200 cm	160 x 200 cm	180 x 200 cm	200 x 200 cm
Art.	7198	7199	7209	7229	7249	7269	7289	7309
BxHxT - LxAxP cm	91 x 88 x 212	101 x 88 x 212	111 x 88 x 212	131 x 88 x 212	151 x 88 x 212	171 x 88 x 212	191 x 88 x 212	211 x 88 x 212
Colli / kg	2 / 28	2 / 30	2 / 32	2 / 36	2 / 40	2 / 43	2 / 46	2 / 49
HOLZART - <i>tipologia del legno</i>								
Fichte - abete €								
Buche - faggio €								
Eiche - rovere €								
Zirbe - cirmolo €								
Nuss - noce €								

metallfrei <i>esente da parti metalliche</i>								
	80 x 200 cm	90 x 200 cm	100 x 200 cm	120 x 200 cm	140 x 200 cm			
						Nachtkästchen mit Ablage comodino con ripiano	Nachtkästchen mit Schublade comodino con cassetto	Nachtk. mit Schubl. auf Metallführungen comod. con cassetto su guide in metallo
Art.	5003	5004	5005	5006	5007	7403	7404	7405
BxHxT - LxAxP cm	79 x 12 x 196	89 x 12 x 196	99 x 12 x 196	119 x 12 x 196	139 x 12 x 196	60 x 48 x 37	60 x 48 x 37	60 x 48 x 37
Colli / kg	1 / 24	1 / 25	1 / 27	1 / 30	1 / 33	1 / 17	1 / 19	1 / 19
HOLZART - <i>tipologia del legno</i>								
Fichte - abete €								
Buche - faggio €								
Eiche - rovere €								
Zirbe - cirmolo €								
Nuss - noce €								

Blume des Lebens <i>fiore della vita</i>							
	80 x 200 cm	90 x 200 cm	100 x 200 cm	120 x 200 cm	140 x 200 cm		
						am Bettkopfteil eingefräst (Durchmesser 28 cm) fresato sulla testata letto (diametro 28 cm)	Zirbe-Paneel inkl. Aufhängebeschlag (Durchm. 46 cm) pannello con ganci d'appendere a muro (diametro 46 cm)
Art.	5033	5034	5035	5036	5037	5043	5045
BxHxT - LxAxP cm	80 x 20 x 200	90 x 20 x 200	100 x 20 x 200	120 x 20 x 200	140 x 20 x 200		60 x 60 x 2,7
Colli / kg	1 / 30	1 / 32	1 / 34	1 / 38	1 / 40		1 / 7
Latex - lattice €							
Zirbe - cirmolo €							



Zirbe
Arve
cirmolo



ZR
roh unbehandelt
grezzo non trattato

metallfrei
esente da parti metalliche



METALLFREIER TELLERROST AUS ZIRBE
Zirbenholzteller aus heimischem Zirbenholz. Belüftung der Matratze durch die zentrale Bohrung des Zirbentellers (bei Druckbelastung der Federn). Federelemente aus thermoplastischem Kautschuk. Verschiedene Härtegrade der Federelemente für einen perfekten Liegekomfort:
helle Zirbenteller = weiche Federelemente (Absenkung im Schulterbereich)
dunklere Zirbenteller = harte Federelemente (austauschbar und individuell anpassbar)
Konstruktionsrahmen aus Buchenholz
empfohlene Einlegetiefe des Bettrahmens: 17 cm

RETE IN CIRMOLO esente da parti metalliche
Dischi in cirmolo dell' Alto Adige. Il foro centrale nel disco consente l' aerazione del materasso.
Molle in gomma (Kautschuk) con 2 durezze che si adattano alla forma del corpo:
dischi bianchi = molle morbide (zona spalle)
dischi più scuri = molle dure
Struttura di sostegno in faggio.
altezza del giroletto consigliata: 17 cm

80 x 200 cm 90 x 200 cm 100 x 200 cm 120 x 200 cm 140 x 200 cm

Art.	5003	5004	5005	5006	5007
BxHxT - LxAxP cm	79 x 12 x 196	89 x 12 x 196	99 x 12 x 196	119 x 12 x 196	139 x 12 x 196
Colli / kg	1 / 24	1 / 25	1 / 27	1 / 30	1 / 33
HOLZART - tipologia del legno					
Zirbe - cirmolo €					



Naturalatexmatratze
7-Zonen Matratze. Höhe: 20 cm
Abnehmbarer und mit 60° waschbarer Überzug

Materasso in lattice naturale
7 zone di portanza differenziata. Altezza: 20 cm
Rivestimento sfoderabile e lavabile in lavatrice (60°)

80 x 200 cm 90 x 200 cm 100 x 200 cm 120 x 200 cm 140 x 200 cm

Art.	5033	5034	5035	5036	5037
BxHxT - LxAxP cm	80 x 20 x 200	90 x 20 x 200	100 x 20 x 200	120 x 20 x 200	140 x 20 x 200
Colli / kg	1 / 30	1 / 32	1 / 34	1 / 38	1 / 40
Latex - lattice €					



<p>A: 48 cm B: 18 cm C: 30 cm</p> <p>Innenmaß cm misura interna cm</p>	metallfrei - esente da parti metalliche			metallfrei - esente da parti metalliche			
	90 x 200	100 x 200	120 x 200	140 x 200	160 x 200	180 x 200	200 x 200
Art.	9290	9300	9320	9340	9360	9380	9400
BxHxT - LxAxP cm	97 x 101 x 209	107 x 101 x 209	127 x 101 x 209	147 x 101 x 209	167 x 101 x 209	187 x 101 x 209	207 x 101 x 209
Colli / kg	3 / 44	3 / 47	3 / 52	3 / 57	3 / 61	3 / 65	3 / 70
HOLZART - tipologia del legno							
Zirbe - cirmolo €							

	metallfrei - esente da parti metalliche						
	<p>Nachttisch comodino</p>	<p>Nachtkästchen mit Ablage comodino con ripiano</p>	<p>Nachtkästchen mit Schublade comodino con cassetto</p>	<p>Nachtk. mit Schubl. auf Metallführungen comod. con cassetto su guide in metallo</p>	<p>Nachttisch-Hocker sgabello</p>	<p>Hängenachtkästchen comodino</p>	<p>Wand- oder Seitenablage mensola comodino</p>
Art.	8044	7403	7404	7405	3580	8049	8047
BxHxT - LxAxP cm	45 x 45 x 45	60 x 48 x 37	60 x 48 x 37	60 x 48 x 37	45 x 45 x 45	52,5 x 19 x 33	40 x 12 x 32
Colli / kg	1 / 14	1 / 17	1 / 19	1 / 19	1 / 8	1 / 8	1 / 6
HOLZART - tipologia del legno							
Zirbe - cirmolo €							

Zirbe
Arve
cirmolo



ZR

roh unbehandelt
grezzo non trattato



Fichte
(Astfichte)
abete



F
mit Wasserlack behandelt
con vernice all'acqua



FR
roh unbehandelt
grezzo non trattato



FS
gebürstet und lackiert
spazzolato e verniciato



FO
mit Öl behandelt
trattato con l'olio



FN
gebürstet, weiß lackiert
spazzolato, verniciato a bianco

Eiche
(Asteiche)
rovere



EO
mit Öl behandelt
trattato con l'olio

Zirbe
Arve
cirmolo



ZR
roh unbehandelt
grezzo non trattato



ZO
mit Öl behandelt
trattato con l'olio

		metallfrei - esente da parti metalliche							
<p>A: 48 cm B: 18 cm C: 30 cm</p> <p>H. Fußteil: 48 cm alt. pediera: 48 cm</p> <p>Innenmaß cm misura interna cm</p>									
		90 x 200	100 x 200	120 x 200	140 x 200	160 x 200	180 x 200	200 x 200	Nachtkästchen mit Schublade auf Metallführungen comodino con cassetto su guide in metallo
Art.		4809	4810	4812	4814	4816	4818	4820	4850
BxHxT - LxAxP cm		97 x 106 x 210	107 x 106 x 210	127 x 106 x 210	147 x 106 x 210	167 x 106 x 210	187 x 106 x 210	207 x 106 x 210	50 x 55 x 42
Colli / kg		2 / 35	2 / 37	2 / 41	2 / 45	2 / 48	2 / 51	2 / 54	1 / 15
HOLZART - tipologia del legno									
Fichte - abete €									
Eiche - rovere €									
Zirbe - cirmolo €									

Steher in Eiche oder Zirbe. Kopfteil, Fußteil und Seitenteile in Fichte gebürstet, weiß lackiert
piedi in rovere o cirmolo. Testata, pediera e sponde laterali in abete spazzolato, verniciato a bianco.

FN / EO €									
FN / ZR(ZO) €									

		metallfrei - esente da parti metalliche							
<p>A: 48 cm B: 18 cm C: 30 cm</p> <p>H. Fußteil: 55 cm alt. pediera: 55 cm</p> <p>Innenmaß cm misura interna cm</p>									
		90 x 200	100 x 200	120 x 200	140 x 200	160 x 200	180 x 200	200 x 200	Kommode mit 2 Schubladen auf Metallführungen cassettiera con 2 cassetti su guide in metallo
Art.		4829	4830	4832	4834	4836	4838	4840	4852
BxHxT - LxAxP cm		97 x 106 x 210	107 x 106 x 210	127 x 106 x 210	147 x 106 x 210	167 x 106 x 210	187 x 106 x 210	207 x 106 x 210	100 x 76 x 42
Colli / kg		2 / 37	2 / 39	2 / 43	2 / 47	2 / 50	2 / 53	2 / 56	1 / 34
HOLZART - tipologia del legno									
Fichte - abete €									
Eiche - rovere €									
Zirbe - cirmolo €									

Steher in Eiche oder Zirbe. Kopfteil, Fußteil und Seitenteile in Fichte gebürstet, weiß lackiert
piedi in rovere o cirmolo. Testata, pediera e sponde laterali in abete spazzolato, verniciato a bianco.

FN / EO €									
FN / ZR(ZO) €									



Fichte
(Astfichte)
abete



FR
roh unbehandelt
grezzo non trattato

Zirbe
Arve
cirmolo

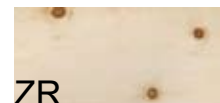

ZR
roh unbehandelt
grezzo non trattato

		metallfrei - esente da parti metalliche											
<p>A: 38 cm B: 16 cm C: 22 cm</p> <p>Innenmaß cm misura interna cm</p>		<p>90 x 200</p>		<p>140 x 200</p>		<p>180 x 200</p>		<p>200 x 200</p>		<p>Nachtkästchen mit Ablage comodino con ripiano</p>		<p>Nachtkästchen mit Schublade comodino con cassetto</p>	
Art.		7409	7414	7418	7420	7401	7402						
BxHxT - LxAxP cm		99 x 79 x 208	149 x 79 x 208	189 x 79 x 208	209 x 79 x 208	60 x 38 x 37	60 x 38 x 37						
Colli / kg		2 / 45	2 / 52	2 / 58	2 / 62	1 / 16	1 / 18						
HOLZART - tipologia del legno													
Fichte - abete €													
Zirbe - cirmolo €													

		metallfrei - esente da parti metalliche													
<p>A: 48 cm B: 16 cm C: 32 cm</p> <p>Innenmaß cm misura interna cm</p>		<p>90 x 200</p>		<p>140 x 200</p>		<p>180 x 200</p>		<p>200 x 200</p>		<p>Nachtkästchen mit Ablage comodino con ripiano</p>		<p>Nachtkästchen mit Schublade comodino con cassetto</p>		<p>Nachtkästchen mit Schublade auf Metallführungen comodino con cassetto su guide in metallo</p>	
		Komforthöhe - altezza comfort													
Art.		7429	7434	7438	7440	7403	7404	7405							
BxHxT - LxAxP cm		99 x 89 x 208	149 x 89 x 208	189 x 89 x 208	209 x 89 x 208	60 x 48 x 37	60 x 48 x 37	60 x 48 x 37							
Colli / kg		2 / 48	2 / 55	2 / 61	2 / 65	1 / 17	1 / 19	1 / 19							
HOLZART - tipologia del legno															
Fichte - abete €															
Zirbe - cirmolo €															

		metallfrei - esente da parti metalliche			
		<p>Wiege mit hohem Kopfteil culla con testata alta</p>		<p>Wiege mit niederem Kopfteil culla con testata bassa</p>	
Art.		Tradition A	Tradition B		
BxHxT - LxAxP cm		68 x 115 x 96	68 x 68 x 96		
Colli / kg		1 / 19	1 / 16		
HOLZART - tipologia del legno					
Zirbe - cirmolo €					

							<p>rot - rosso</p> <p>blau - blu</p> <p>Natur - beige</p>	
Art.		Wollmatratze materasso lana	Wollbettchen piumino lana	Kissen cuscino	Bettüberzug copripiumino	Kissenüberzug federa	Baldachin baldacchino	Farben - colori
€								



 A: 41 cm B: 16 cm C: 25 cm	 90 x 200 Fußteil nieder - <i>pediera bassa</i>	 180 x 200 Fußteil 55 cm hoch - <i>altezza pediera 55 cm</i>	 90 x 200 Fußteil 55 cm hoch - <i>altezza pediera 55 cm</i>	 180 x 200 Fußteil 55 cm hoch - <i>altezza pediera 55 cm</i>
	Art. 6608	6618	6609	6628
BxHxT - LxAxP cm	103 x 89 x 211	193 x 89 x 211	103 x 89 x 211	193 x 89 x 211
Colli / kg	2 / 30	2 / 45	2 / 30	2 / 45
HOLZART - <i>tipologia del legno</i>				
Fichte - abete €				
Zirbe - cirmolo €				

 A: 41 cm B: 16 cm C: 25 cm	 180 x 200 Fußteil nieder - <i>pediera bassa</i>	 Nachtkästchen <i>comodino</i>	 Nachtkästchen <i>comodino</i>	 Kommode <i>cassettiera</i>	 Kommode <i>cassettiera</i>	 Aussenseite <i>fianco esterno</i>
	Art. 6718	6540	6640	6644	6647	6612
BxHxT - LxAxP cm	193 x 100 x 211	48 x 46 x 42	49 x 56 x 37	108 x 82 x 47	76 x 125 x 47	3 x 226 x 58
Colli / kg	2 / 45	1 / 13	1 / 15	1 / 35	1 / 43	1 / 20
HOLZART - <i>tipologia del legno</i>						
Fichte - abete €						
Zirbe - cirmolo €						

Grundbauschränke ohne Aussenseiten (Art. 6612), Sockel (Art. 6613) und Kranzabschluss (Art. 6614) <i>elementi base, senza fianchi esterni (art. 6612), zoccolo (art. 6613) e cornice superiore (art. 6614)</i>								
Art.	6601	6602	6603	6604	6605	6606	6613	6614
BxHxT - LxAxP cm	53 x 226 x 58	53 x 226 x 58	53 x 226 x 58	53 x 226 x 58	105 x 226 x 58	105 x 226 x 58	100 x 9 x 3	100 x 5 x 10
Colli / kg	2 / 46	2 / 46	2 / 58	2 / 58	3 / 68	3 / 80	1 / 2	1 / 3
HOLZART - <i>tipologia del legno</i>								
Fichte - abete €								
Zirbe - cirmolo €								

Fichte (Astfichte) abete F mit Wasserlack behandelt <i>con vernice all'acqua</i>	FR roh unbehandelt <i>grezzo non trattato</i>	FS gebürstet und lackiert <i>spazzolato e verniciato</i>	FO mit Öl behandelt <i>trattato con l'olio</i>	FN gebürstet, weiß lackiert <i>spazzolato, verniciato a bianco</i>
Zirbe Arve cirmolo ZR roh unbehandelt <i>grezzo non trattato</i>	ZO mit Öl behandelt <i>trattato con l'olio</i>			

Griffart *tipo maniglia*

9901 Holzknopf rund <i>pomello legno</i>	9903 Metallknopf INOX <i>pomello metallo INOX</i>
---	--

Beispiele Schrankzusammenstellungen esempi combinazioni armadi	 6605 + 2x 6612 + 1,05x 6613 + 2,25x 6614	 6605 + 6602 + 2x 6612 + 1,58x 6613 + 2,78x 6614	 1 x 6601 + 1 x 6606 + 1 x 6602 + 2 x 6612 + 2,1 x 6613 + 3,3 x 6614	 2 x 6605 + 1 x 6603 + 2 x 6612 + 2,63 x 6613 + 3,83 x 6614	 3 x 6605 + 2 x 6612 + 3,15 x 6613 + 4,35 x 6614
	Art. 6702	6703	6714	6715	6706
BxHxT - LxAxP cm	116 x 231 x 61	169 x 231 x 61	221 x 231 x 61	274 x 231 x 61	326 x 231 x 61
HOLZART - <i>tipologia del legno</i>					
Fichte - abete €					
Zirbe - cirmolo €					



Fichte (Astfichte) abete



F
mit Wasserlack behandelt
con vernice all'acqua



FR
roh unbehandelt
grezzo non trattato



FS
gebürstet und lackiert
spazzolato e verniciato



FO
mit Öl behandelt
trattato con l'olio



FN
gebürstet, weiß lackiert
spazzolato, verniciato a bianco

Buche (Kernbuche) faggio



BU
mit Wasserlack behandelt
con vernice all'acqua



BN
"Nuss" gebeizt und lackiert
tinto noce e verniciato

Zirbe Arve cirmolo

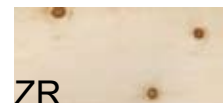

ZR
roh unbehandelt
grezzo non trattato



ZO
mit Öl behandelt
trattato con l'olio

Griffart
tipo maniglia



9901
Holzknopf rund
pomello legno



9903
Metallknopf INOX
pomello metallo INOX

		Trennbares Doppelbett letto doppio separabile								
<p>A: 38 cm B: 13 cm C: 25 cm <i>*Maß für Lattenrost *misura per rete</i></p>										
		90 x 200	*89 x 200	*89 x 200	160 x 200	180 x 200	Lattenrost 89x198 rete a doghe	Nachtkästchen comodino	Nachtkästchen comodino	
		Art.	2785	2788	2789	2796	2798	5002	2840	2940
BxHxT - LxAxP cm		97 x 42 x 208	94 x 42 x 208	94 x 42 x 208	167 x 42 x 208	187 x 42 x 208	89 x 5 x 198	55 x 39 x 40	45 x 33 x 39	
Colli / kg		2 / 26	2 / 25	2 / 25	2 / 35	2 / 38	1 / 8	1 / 13	1 / 9	
HOLZART - tipologia del legno										
Fichte - abete €										
Buche - faggio €										
Zirbe - cirmolo €										

		Wandtäfelung (Tiefe: 5 cm) rivestimento parete (profondità: 5 cm)				Wandtäfelung (Tiefe: 15 cm) rivestimento parete (profondità: 15 cm)				
		li. - sx		re. - dx		li. - sx		re. - dx		
										Spiegel-Garderobe bitte Spiegel links od. rechts angeben specchio-guard.
		Art.	2906	2907	2908 / 2909	2916	2917	2918 / 2919	2981	2758
BxHxT - LxAxP cm		50 x 81 x 5	100 x 3 x 6	2 x 84 x 7	50 x 81 x 14	100 x 3 x 15	2 x 84 x 16	51 x 140 x 6	78 x 133 x 8	
Colli / kg		1 / 5	1 / 1	1 / 1	1 / 5	1 / 1	1 / 1	1 / 9	1 / 16	
HOLZART - tipologia del legno										
Fichte - abete €										
Buche - faggio €										
Zirbe - cirmolo €										

		Schrank mit Wäscheeinteilung armadio c. divisorio			Garderobe guardaroba		Kofferbock appoggia valigie		Spiegelpaneel pann. con specchio		Garderobepaneel pann. guardaroba	
		Art.	2902	2905	2903	2971	2925	2756	2755			
BxHxT - LxAxP cm		105 x 206 x 59	105 x 206 x 59	154 x 206 x 59	50-100 x 206 x 54	80 x 57 x 44	39 x 133 x 6	39 x 133 x 6	39 x 133 x 8			
Colli / kg		2 (3) / 76	3 / 89	3 (4) / 98	1 (2) / 30	1 / 11	1 / 9	1 / 7				
HOLZART - tipologia del legno												
Fichte - abete €												
Buche - faggio €												
Zirbe - cirmolo €												

		ohne Platte senza copertura			ohne Platte senza copertura		ohne Platte senza copertura		Sichtkanten angeben indicare bordi a vista			
		Art.	2961	2962	2963	2930	2954	2965	2927	2808		
BxHxT - LxAxP cm		55 x 72 x 51	104 x 72 x 51	104 x 72 x 51	100 x 3 x 53		3 x 72 x 51	70 x 73 x 70	42 x 90 x 47			
Colli / kg		1 / 20	1 / 28	1 / 28	1 / 7		1 / 6	1 / 11	1 / 6			
HOLZART - tipologia del legno												
Fichte - abete €												
Buche - faggio €												
Zirbe - cirmolo €												



Fichte (Astfichte) abete



F
mit Wasserlack behandelt
con vernice all'acqua



FR
roh unbehandelt
grezzo non trattato



FS
gebürstet und lackiert
spazzolato e verniciato



FO
mit Öl behandelt
trattato con l'olio



FN
gebürstet, weiß lackiert
spazzolato, verniciato a bianco

Zirbe Arve cirmolo

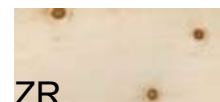

ZR
roh unbehandelt
grezzo non trattato



ZO
mit Öl behandelt
trattato con l'olio

Griffart
tipo maniglia



9901
Holzknopf rund
pomello legno



9903
Metallknopf INOX
pomello metallo INOX

		Trennbare Doppelbett letto doppio separabile							
<p>A: 38 cm B: 13 cm C: 25 cm</p> <p>*Maß für Lattenrost *misura per rete</p>									
		Kopftäfelung testata letto	Kopftäfelung testata letto	Bett 180x200 letto 180x200	Bett 180x200 letto 180x200	Bett 90x200 letto 90x200	Bett links 90x200 letto sx 90x200	Bett rechts 90x200 letto dx 90x200	
		Art.	6510	6515	6518	2798	2785	2788	2789
BxHxT - LxAxP cm			206 x 153 x 5	193 x 105 x 8	193 x 66 x 208	187 x 42 x 208	97 x 42 x 208	94 x 42 x 208	94 x 42 x 208
Colli / kg			1 / 23	1 / 19	2 / 42	2 / 38	2 / 26	2 / 25	2 / 25
HOLZART - tipologia del legno									
Fichte - abete €									
Zirbe - cirmolo €									

		Wandtäfelung (Tiefe: 5 cm) rivestimento parete (profondità: 5 cm)								
		Wandtäfler pannello rivestim.	Abdeckbrett listello copertura Lfm - m lin.	seitl. Abschlüsse copertura laterale	Nachtkästchen comodino	Nachtkästchen comodino	Kofferbock appoggia valigie	Spiegel+Gard. bitte Spiegel links od. rechts angeben specchio+guard.	Kommode cassettiera	
		Art.	2906	2907	2908 / 2909	6540	2940	2925	2758	6544
BxHxT - LxAxP cm			50 x 81 x 5	100 x 3 x 6	2 x 84 x 7	48 x 46 x 42	45 x 33 x 39	80 x 57 x 44	78 x 133 x 8	108 x 82 x 47
Colli / kg			1 / 5	1 / 1	1 / 1	1 / 13	1 / 7	1 / 11	1 / 16	1 / 35
HOLZART - tipologia del legno										
Fichte - abete €										
Zirbe - cirmolo €										







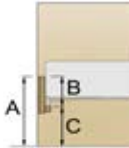

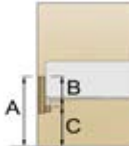

		Drehtürenschränke armadi con ante battenti			Schiebetürenschränke armadi con ante scorrevoli		
		Art.	6502	6503	6504	6523	6524
BxHxT - LxAxP cm			125 x 210 x 61	177 x 210 x 61	230 x 210 x 61	177 x 210 x 61	230 x 210 x 61
Colli / kg			3 / 65	4 / 96	4 / 130	3 / 96	4 / 130
HOLZART - tipologia del legno							
Fichte - abete €							
Zirbe - cirmolo €							







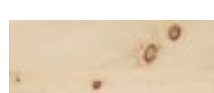

		ohne Platte senza copertura		ohne Platte senza copertura		Sichtkanten angeben indicare bordi a vista				
		Kommode comò	Platte zu Art. 6551 piano copert. 6551	Kommode comò	Platte zu Art. 6552 piano copert. 6552	Platte pro lfm piano per m lin.	Schreibtisch scrivania			
		Art.	6551	2928	6552	2929	2930	2933	6551-2932-2954	2808
BxHxT - LxAxP cm			56 x 72 x 53	59 x 3 x 53	105 x 72 x 53	108 x 3 x 53	100 x 3 x 53	140 x 3 x 70	140 x 75 x 70	42 x 90 x 47
Colli / kg			1 / 17	1 / 4	1 / 25	1 / 7	1 / 7	1 / 12	3 / 34	1 / 6
HOLZART - tipologia del legno										
Fichte - abete €										
Zirbe - cirmolo €										

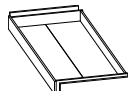

	Einzelbetten letti singoli	Stockbett zerlegbar in 2 Einzelbetten letto a castello divisibile in 2 letti	Stockbett mit schräger Leiter letto a castello c. scaletta inclinata	Stockbett mit Leiter am Fußteil letto castello c. scaletta sulla pediera
				
A: 36 cm B: 11 cm C: 25 cm				
Innenmaß cm misura interna cm	90 x 200	90 x 200	90 x 200	90 x 200
Art.	5109	5108	5100	5117
BxHxT - LxAxP cm	99 x 67 x 212	99 x 67 x 212	99 x 173 x 212	151 x 173 x 212
Colli / kg	2 / 24	2 / 26	4 / 54	4 / 56
HOLZART - tipologia del legno				
Fichte - abete €				
Buche - faggio €				
Eiche - rovere €				
Zirbe - cirmolo €				

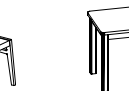
	Hochbetten letti rialzati	Hochbett mit Rutsche letto rialzato con scivolo	Eck-Stockbett letto a castello ad angolo
			
A: 36 cm B: 11 cm C: 25 cm			
Innenmaß cm misura interna cm	90 x 200	140 x 200	90 x 200
Art.	5130	5140	5180
BxHxT - LxAxP cm	140 x 138 x 212	190 x 138 x 212	151 x 173 x 212
Colli / kg	4 / 44	4 / 58	4 / 52
HOLZART - tipologia del legno			
Fichte - abete €			
Buche - faggio €			
Eiche - rovere €			
Zirbe - cirmolo €			

Fichte (Astfichte) abete	 F mit Wasserlack behandelt con vernice all'acqua	 FR roh unbehandelt grezzo non trattato	 FS gebürstet und lackiert spazzolato e verniciato	 FO mit Öl behandelt trattato con l'olio	 FN gebürstet, weiß lackiert spazzolato, verniciato a bianco
Buche (Kernbuche) faggio	 BU mit Wasserlack behandelt con vernice all'acqua	 BN "Nuss" gebeizt und lackiert tinto noce e verniciato			
Eiche (Asteiche) rovere	 EO mit Öl behandelt trattato con l'olio				
Zirbe Arve cirmolo	 ZR roh unbehandelt grezzo non trattato	 ZO mit Öl behandelt trattato con l'olio	Griffart tipo maniglia	 9900 Griffleiste aus Holz listello maniglia in legno	 9903 Metallknopf INOX pomello metallo INOX

								
	Bettenschublade auf Rollen cassetto estraibile su rotelle	Nachtkästchen comodino	Ablage für oberes Bett piano appoggio per letto superiore	Ausfallschutz sponda sicurezza	Stuhl sedia	Zimmertisch tavolino	Wandregal libreria da parete	Wandregal libreria da parete
Art.	5150	5020	5021	5105	3600	2807	2515	2518
BxHxT - LxAxP cm	78 x 21 x 200	50 x 46 x 40	40 x 9 x 30	160 x 37 x 6	40 x 90 x 50	80 x 76 x 58	100 x 40 x 19	85 x 40 x 19
Colli / kg	1 / 18	1 / 8	1 / 2	1 / 3	1 / 7	1 / 13	1 / 4	1 / 3
HOLZART - tipologia del legno								
Fichte - abete €								
Buche - faggio €								
Eiche - rovere €								
Zirbe - cirmolo €								



<p>A: 42 cm C: 33 cm D: 50 cm</p>						
	Couchbett mit gelochter Massivholzplatte (als Lattenrost für Matratze) <i>letto-divano con pannello forato (supporto per materasso)</i>	Ausziehbett <i>letto estraibile</i>	Kaltschaummatratze mit abnehmbarem und waschbarem Überzug <i>materasso (schiumato a freddo) sfoderabile e lavabile</i>	Couchbett 80 x 200 cm, mit Ausziehbett und 2 Matratzen (80 x 200 cm) Liegehöhe: 50 cm <i>letto-divano 80 x 200 cm, con letto estraibile e 2 materassi 80 x 200 cm altezza con materasso: 50 cm</i>		
Innenmaß cm misura interna cm	80 x 200	90 x 200	80 x 200	90 x 200		
Art.	3758	3759	3760	3768	3769	3758, 3760, 2x 3768
BxHxT - LxAxP cm	87 x 42 x 206	97 x 42 x 206	83 x 40 x 199	80 x 17 x 200	90 x 17 x 200	
Colli / kg	2 / 33	2 / 34	1 / 26	1 / 9	1 / 10	

HOLZART - tipologia del legno

Fichte - abete €						
Buche - faggio €						
Eiche - rovere €						
Zirbe - cirmolo €						
Nuss - noce €						

Zubehör für Couchbett Art. 3758 und 3759
accessori per letto art. 3758 e 3759

rivestimento parete con ganci	2 schienali imbottiti incluso tessuto in Loden	fodera materasso con tessuto Loden	armadio con 2 ante	portavaligie	specchio	guardaroba con appendini in metallo	
Art.	3738	3772	3770	8105	7407	3657	3658
BxHxT - LxAxP cm	200 x 38 x 2,7	200 x 40 x 25 (15)	200 x 80(90)	105 x 210 x 58	100 x 52 x 47	40 x 145 x 3	40 x 145 x 6
Colli / kg	1 / 13	1 / 5	1 / 2	3 / 65	1 / 23	1 / 11	1 / 10

HOLZART - tipologia del legno

Fichte - abete €						
Buche - faggio €						
Eiche - rovere €						
Zirbe - cirmolo €						
Nuss - noce €						

<p>Fichte (Astfichte) abete</p> <p>F mit Wasserlack behandelt con vernice all'acqua</p>	<p>FR roh unbehandelt grezzo non trattato</p>	<p>FS gebürstet und lackiert spazzolato e verniciato</p>	<p>FO mit Öl behandelt trattato con l'olio</p>	<p>FN gebürstet, weiß lackiert spazzolato, verniciato a bianco</p>
<p>Buche (Kernbuche) faggio</p> <p>BU mit Wasserlack behandelt con vernice all'acqua</p>	<p>BN "Nuss" gebeizt und lackiert tinto noce e verniciato</p>	<p>Nuss (amerikanisch) noce americano</p>	<p>NO mit Öl behandelt trattato con l'olio</p>	
<p>Eiche (Asteiche) rovere</p> <p>EO mit Öl behandelt trattato con l'olio</p>				
<p>Zirbe Arve cirmolo</p> <p>ZR roh unbehandelt grezzo non trattato</p>	<p>ZO mit Öl behandelt trattato con l'olio</p>			



Systemschrank armadio componibile								
	Maßänderung und Konfigurationsmöglichkeit auf www.gaderform.com armadi su misura da configurare su www.gaderform.com							
Art.	8001	8002	8005	8004	8006	8024	8016	8023
BxHxT - LxAxP cm	53 x 226 x 58	53 x 226 x 58	105 x 226 x 58	105 x 226 x 58	105 x 226 x 58	105 x 89 x 58	105 x 38 x 58	105 x 99 x 58
Colli / kg	2 (3) / 46	2 (3) / 46	3 / 68	3 / 80	3 / 80	2 / 46	1 / 28	1 (2) / 39
HOLZART - tipologia del legno								
Fichte - abete €								
Buche - faggio €								
*Eiche - rovere €								
*Zirbe - cirmolo €								
*Nuss - noce €								

* möglicher Preisabschlag; Korpus und Innenfächer in Fichte / Front in Eiche, Zirbe oder Nuss
 possibile riduzione prezzo; corpo e ripiani in abete / frontali e zoccolo in rovere, cirmolo o noce **-15%**

Zubehör accessori							
	durchgehender Sockel je LFM zoccolo continuo per metro lineare	Fachboden ripiano	Fachboden ripiano	Innenschubladen cassettiera interna	Seitenpaneel fianco armadio	Eckschrank links angolo sinistro	Eckschrank rechts angolo destro
Art.	8013	8027	8028	8032	8009	8017	8018
BxHxT - LxAxP cm	— x 8 x 3	49 x 2 x 49	101 x 2 x 50	101 x 41 x 50	58 x 226 x 2	105 (113) x 226 x 58	105 (113) x 226 x 58
Colli / kg	1 / 2	1 / 2	1 / 4	1 / 17	1 / 14	3 / 68	3 / 68
HOLZART - tipologia del legno							
Fichte - abete €							
Buche - faggio €							
Eiche - rovere €							
Zirbe - cirmolo €							
Nuss - noce €							

Fichte (Astfichte) abete	F mit Wasserlack behandelt con vernice all'acqua	FR roh unbehandelt grezzo non trattato	FS gebürstet und lackiert spazzolato e verniciato	FO mit Öl behandelt trattato con l'olio	FN gebürstet, weiß lackiert spazzolato, verniciato a bianco
--------------------------	---	---	--	--	--

Buche (Kernbuche) faggio	BU mit Wasserlack behandelt con vernice all'acqua	BN "Nuss" gebeizt und lackiert tinto noce e verniciato
--------------------------	--	---

Eiche (Asteiche) rovere	EO mit Öl behandelt trattato con l'olio
-------------------------	--

Zirbe Arve cirmolo	ZR roh unbehandelt grezzo non trattato	ZO mit Öl behandelt trattato con l'olio	NO mit Öl behandelt trattato con l'olio
--------------------	---	--	--

Griffart tipo maniglia	9900 Griffleiste aus Holz listello maniglia in legno
---------------------------	---

Beispiele esempi				
	Schrankszusammenstellungen mit durchgehendem Sockel armadi con zoccolo continuo			
Art.	8005, 8005, 8013 x 2,1	8005, 8006, 8013 x 2,1	8005, 8024, 8016, 8023, 8013 x 2,1	8005, 8005, 8002, 8013 x 2,63
BxHxT - LxAxP cm	210 x 226 x 58	210 x 226 x 58	210 x 226 x 58	263 x 226 x 58
HOLZART - tipologia del legno				
Fichte - abete €				
Buche - faggio €				
Eiche - rovere €				
Zirbe - cirmolo €				
Nuss - noce €				



offene Garderobenschränke
armadi guardaroba a giorno

ohne Sockelboden
senza piano base

mit 4 Schubladen
con 4 cassetti

mit 2 Schubladen
con 2 cassetti

mit 4 Schubladen
con 4 cassetti

Eckelement
angolo

Art.	8502	8503	8505	8504	8506	8507	8508	8509
BxHxT - LxAxP cm	105 x 226 x 58	53 x 226 x 58	105 x 226 x 58	53 x 226 x 58	105 x 226 x 58	105 x 226 x 58	105 x 226 x 58	105 x 226 x 105
Colli / kg	2 / 57	2 / 42	2 / 60	2 (3) / 54	3 / 66	3 / 72	3 / 78	4 / 90

HOLZART - tipologia del legno

Fichte - abete €								
Fichte (Schubladenvorderstücke in Buche, Eiche oder Zirbe) abete (frontali in faggio, rovere o in cirmolo)								
Buche - faggio €								
Eiche - rovere €								
Zirbe - cirmolo €								

Fichte
(Astfichte)
abete

F
mit Wasserlack behandelt
con vernice all'acqua

FR
roh unbehandelt
grezzo non trattato

FS
gebürstet und lackiert
spazzolato e verniciato

FO
mit Öl behandelt
trattato con l'olio

FN
gebürstet, weiß lackiert
spazzolato, verniciato a bianco

Buche
(Kernbuche)
faggio

BU
mit Wasserlack behandelt
con vernice all'acqua

BN
"Nuss" gebeizt und lackiert
tinto noce e verniciato

Eiche
(Asteiche)
rovere

EO
mit Öl behandelt
trattato con l'olio

Zirbe
Arve
cirmolo

ZR
roh unbehandelt
grezzo non trattato

ZO
mit Öl behandelt
trattato con l'olio

Griffart
tipo maniglia

Griffausfräsung bei Kommoden
maniglia fresata su comò e cassettiere



	<p>2-türiger Schiebetürenschränk auf Maß armadio su misura con 2 ante scorrevoli</p> <p>Max.Höhe - alt. mass.: 237 cm Min.Höhe - alt. min.: 180 cm</p> <p>Max.Breite - largh. mass.: 230 cm Min.Breite - largh. min.: 120 cm</p> <p>inkl. Sockelfüße zur Höhenverstellung incluso piedini regolatori d'altezza</p> <p>Preis = B (Breite in m) x Einheitspreis prezzo = B (larghezza in m) x prezzo unitario</p>	<p>Beispiel esempio</p> <p>2,00 x Einheitspreis 2,00 x prezzo unitario</p>
Art.	3730	3730 (x2,00)
BxHxT - LxAxP cm	(Achtung Mindestbreite = 120 cm, maximale Breite = 230 cm)	
Colli / kg	(attenzione: larghezza minima = 120 cm, larghezza massima 230 cm)	
HOLZART - tipologia del legno		
Fichte - abete €		
Buche - faggio €		x Breite (Mindestbreite = 1,2)
Eiche - rovere €		x larghezza (larghezza minima = 1,2)
Zirbe - cirmolo €		

	<p>Schränke mit 2 rahmenlosen SCHIEBETÜREN armadi con 2 ante scorrevoli</p> <p>Maßänderung und Konfigurationsmöglichkeit auf www.gaderform.com armadi su misura da configurare su www.gaderform.com</p>			
Art.	3720	3721	3722	3724
BxHxT - LxAxP cm	120 x 210 x 65	180 x 210 x 65	155 x 231 x 65	205 x 231 x 65
Colli / kg	5 / 82	7 / 110	7 / 110	7 / 142
HOLZART - tipologia del legno				
Fichte - abete €				
Buche - faggio €				
Eiche - rovere €				
Zirbe - cirmolo €				

Fichte (Astfichte) abete	F mit Wasserlack behandelt con vernice all'acqua	FR roh unbehandelt grezzo non trattato	FS gebürstet und lackiert spazzolato e verniciato	FO mit Öl behandelt trattato con l'olio	FN gebürstet, weiß lackiert spazzolato, verniciato a bianco
---------------------------------	--	--	---	---	---

Buche (Kernbuche) faggio	BU mit Wasserlack behandelt con vernice all'acqua	BN "Nuss" gebeizt und lackiert tinto noce e verniciato
---------------------------------	---	--

Eiche (Asteiche) rovere	EO mit Öl behandelt trattato con l'olio
--------------------------------	---

Zirbe Arve cirmolo	ZR roh unbehandelt grezzo non trattato	ZO mit Öl behandelt trattato con l'olio
---------------------------	--	---

Griffart tipo maniglia	
Griffausfräsung bei Kommoden maniglia fresata su comò e cassettiere	

	<p>3-türiger Schiebetürenschränk auf Maß armadio su misura con 3 ante scorrevoli</p> <p>Preis = B (Breite in m) x Einheitspreis prezzo = B (larghezza in m) x prezzo unitario</p> <p>Beispiel: 3m Breite esempio: largh. 3m</p> <p>Innenschubladen cassettiere interna 1 Fachboden 1 ripiano Kommode cassettiere Kommode cassettiere</p>					
Art.	3733	3734	B-2052	2099	3653	3654
BxHxT - LxAxP cm		300 x 231 x 65	98 x 41 x 50	98 x 2 x 50	115 x 74 x 45	115 x 95 x 45
Colli / kg		10 / 198	1 / 17	1 / 4	1 / 37	1 / 47
HOLZART - tipologia del legno						
Fichte - abete €		x Breite (von 2,50 m bis 3,30 m Breite)				
Buche - faggio €						
Eiche - rovere €		x larghezza (da 2,50 m a 3,30 m di larghezza)				
Zirbe - cirmolo €						



	Grundbauelemente elementi base			Fortbauelemente elementi componibili				Eckelement angolo
Art.	2141	2142	2143	2144	2145	2146	2148	2147
BxHxT - LxAxP cm	53 x 238 x 59	102 x 238 x 59	102 x 238 x 59	51 x 238 x 59	51 x 238 x 59	100 x 238 x 59	100 x 238 x 59	102 x 238 x 59
Colli / kg	2 / 51	3 / 80	3 / 76	2 / 40	2 / 47	2 / 64	3 / 68	2 / 65
HOLZART - tipologia del legno								
Fichte - abete €								
Buche - faggio €								
Zirbe - cirmolo €								

Beispiele esempi				
	Art.	2143 + 2146	2141 + 2148 + 2146	2143 + 2146 + 2146
BxHxT - LxAxP cm	202 x 238 x 59	253 x 238 x 59	302 x 238 x 59	212 x 238 x 160
HOLZART - tipologia del legno				
Fichte - abete €				
Buche - faggio €				
Zirbe - cirmolo €				

Fichte (Astfichte) abete

F mit Wasserlack behandelt con vernice all'acqua

FR roh unbehandelt grezzo non trattato

FS gebürstet und lackiert spazzolato e verniciato

FO mit Öl behandelt trattato con l'olio

FN gebürstet, weiß lackiert spazzolato, verniciato a bianco

Buche (Kernbuche) faggio

BU mit Wasserlack behandelt con vernice all'acqua

BN "Nuss" gebeizt und lackiert tinto noce e verniciato

Zirbe Arve cirmolo

ZR roh unbehandelt grezzo non trattato

ZO mit Öl behandelt trattato con l'olio

Griffart tipo maniglia

9900 Griffleiste aus Holz listello maniglia in legno

9901 Holzknopf rund pomello legno

9903 Metallknopf INOX pomello metallo INOX

Zubehör accessori	zu - per art. 2145 zu - per art. 2141					
Art.	2050	2099	2669	2052	2675	2677
BxHxT - LxAxP cm	49 x 2 x 50	98 x 2 x 50	98 x 147 x 49	98 x 41 x 50	37 x 100	38 x 162
Colli / kg	1 / 2	1 / 4	1 / 15	1 / 17		
HOLZART - tipologia del legno						
Fichte - abete €						
Buche - faggio €						
Zirbe - cirmolo €						



	<p>$0,25m + 0,25m + 0,50m = 1,00m$</p> <p>$B + H + T (l+a+p) = 1,00 m$</p>	<p>$min. 0,25m + min. 0,20m + min. 0,25m = 0,70m$</p> <p>$B+H+T (L+A+P) = 0,70 m$</p>	<p>$max. 0,45m + max. 0,35m + max. 1,20m = 2,00m$</p> <p>$B + H + T (l+a+p) = 2,00 m$</p>	<p>$B+H+T (L+A+P) = 1,20 m$</p>	<p>$B+H+T (L+A+P) = 1,65 m$</p>
	Wandregal (Preis x Summe B+H+T) libreria a parete (prezzo x somma L+A+P)	kleinste Maße misure minime	maximale Maße misure massime	Beispiele esempi	
Art.	8050	B-8050	B-8050	B-8050	B-8050
BxHxT - LxAxP cm	B + H + T (l+a+p) = 100 cm	25 x 25 x 20	120 x 45 x 35	70 x 25 x 25	115 x 25 x 25
Colli / kg	1 / 7	1 / 4	1 / 20	1 / 9	1 / 12

HOLZART - tipologia del legno

Fichte - abete €					
Buche - faggio €					
Eiche - rovere €					
Zirbe - cirmolo €					
Nuss - noce €					

	<p>Unterteil offen base</p>	<p>Unterteil m.Laden base con cassetti</p>	<p>Unterteil offen base</p>	<p>Unterteil m.Laden base con cassetti</p>	<p>Hängeregale libreria sospesa</p>	<p>Hängeregale libreria sospesa</p>	<p>Hängekommode comò sospeso</p>
Art.	8061	8062	8051	8052	8055	8056	8058
BxHxT - LxAxP cm	105 x 45 x 51	105 x 45 x 51	105 x 45 x 41	105 x 45 x 41	52,5 x 38 x 41	105 x 38 x 41	105 x 38 x 41
Colli / kg	1 / 27	1 / 32	1 / 24	1 / 29	1 / 13	1 / 23	1 / 28

HOLZART - tipologia del legno

Fichte - abete €							
Buche - faggio €							
Eiche - rovere €							
Zirbe - cirmolo €							
Nuss - noce €							

<p>Fichte (Astfichte) abete</p> <p>F mit Wasserlack behandelt con vernice all'acqua</p>	<p>FR roh unbehandelt grezzo non trattato</p>	<p>FS gebürstet und lackiert spazzolato e verniciato</p>	<p>FO mit Öl behandelt trattato con l'olio</p>	<p>FN gebürstet, weiß lackiert spazzolato, verniciato a bianco</p>
<p>Buche (Kernbuche) faggio</p> <p>BU mit Wasserlack behandelt con vernice all'acqua</p>	<p>BN "Nuss" gebeizt und lackiert tinto noce e verniciato</p>	<p>Nuss (amerikanisch) noce americano</p>	<p>NO mit Öl behandelt trattato con l'olio</p>	
<p>Eiche (Asteiche) rovere</p> <p>EO mit Öl behandelt trattato con l'olio</p>				
<p>Zirbe Arve cirmolo</p> <p>ZR roh unbehandelt grezzo non trattato</p>	<p>ZO mit Öl behandelt trattato con l'olio</p>	<p>Griffart tipo maniglia</p>	<p>9900 Griffleiste aus Holz listello maniglia in legno</p>	



<p>Fichte (Astfichte) abete</p> <p>F mit Wasserlack behandelt con vernice all'acqua</p>	<p>FR roh unbehandelt grezzo non trattato</p>	<p>FS gebürstet und lackiert spazzolato e verniciato</p>	<p>FO mit Öl behandelt trattato con l'olio</p>	<p>FN gebürstet, weiß lackiert spazzolato, verniciato a bianco</p>
<p>Buche (Kernbuche) faggio</p> <p>BU mit Wasserlack behandelt con vernice all'acqua</p>	<p>BN "Nuss" gebeizt und lackiert tinto noce e verniciato</p>	<p>Nuss (amerikanisch) noce americano</p> <p>NO mit Öl behandelt trattato con l'olio</p>	<p>Altholz legno vecchio</p> <p>AF gebürstet spazzolato</p>	
<p>Eiche (Asteiche) rovere</p> <p>EO mit Öl behandelt trattato con l'olio</p>				
<p>Zirbe Arve cirmolo</p> <p>ZR roh unbehandelt grezzo non trattato</p>	<p>ZO mit Öl behandelt trattato con l'olio</p>	<p>Griffart tipo maniglia</p> <p>Griffausfräsung bei Kommoden maniglia fresata su comò e cassettiere</p>		

Art.	3614	3616	3650	3608	3657	3658
BxHxT - LxAxP cm	167 x 47 x 35	35 x 136 x 35	___ x ___ x 5,5	167 x 52 x 56	40 x 145 x 3	40 x 145 x 6
Colli / kg	1 (2) / 59	1 / 25	1 / 15	2 / 72	1 / 11	1 / 10
HOLZART - tipologia del legno						
Fichte - abete €						
Buche - faggio €						
Eiche - rovere €						
Zirbe - cirmolo €						
Nuss - noce €						
Altholz Fichte - abete vecchio €						

Art.	3630	3632	3635	3636	3637	3638
BxHxT - LxAxP cm	45 x 187 x 45	85 x 98 x 46	120 x 45 x 46	100 x 6 x 47	120 x 50 x 2	100 x 52 x 6
Colli / kg	1 / 32	1 / 36	1 / 26	1 / 4	1 / 6	1 / 4
HOLZART - tipologia del legno						
Fichte - abete €						
Buche - faggio €						
Eiche - rovere €						
Zirbe - cirmolo €						
Nuss - noce €						

Art.	3642	3644	3646	3648	3653	3654
BxHxT - LxAxP cm	90 x 52 x 46	180 x 52 x 46	90 x 74 x 46	180 x 74 x 46	115 x 74 x 46	115 x 95 x 46
Colli / kg	1 / 24	1 / 46	1 / 28	1 / 54	1 / 37	1 / 47
HOLZART - tipologia del legno						
Fichte - abete €						
Buche - faggio €						
Eiche - rovere €						
Zirbe - cirmolo €						
Nuss - noce €						



	Unterteil mit Schublade base con cassetto	Unterteil m.Schubladen base con cassetti	Unterteil m.Schubladen base con cassetti	Untert.mit Schiebetüren base con ante scorrev.	Regal m. 2 Schubladen libreria con 2 cassetti	Schrank mit Glstüren armadietto / ante vetro
Art.	3604	3606	3608	3609	3622	3624
BxHxT - LxAxP cm	127 x 31 x 56	167 x 31 x 56	167 x 52 x 56	167 x 52 x 56	44 x 187 x 35	85 x 187 x 35
Colli / kg	1 / 30	1 / 40	2 / 72	2 / 60	1 / 45	2 / 65

	Wandregal offen libreria a parete	Wandregal m. Schiebet. libreria sospesa con ante scorrevoli	Wandkommode mit Schubladen cassettiera sospesa	Wandschrank armadietto sospeso	Preis pro Lfm (von 1,00 bis 2,20 m) prezzo per m.lineare (da 1,00 a 2,20 m)
Art.	3610	3612	3614	3616	8306
BxHxT - LxAxP cm	167 x 35 x 35	167 x 35 x 35	167 x 47 x 35	35 x 136 x 35	100 x 100 x 5,5
Colli / kg	1 / 38	1 (2) / 48	1 (2) / 59	1 / 25	1 / 14

Fichte (Astfichte) abete
F mit Wasserlack behandelt con vernice all'acqua
FR roh unbehandelt grezzo non trattato
FS gebürstet und lackiert spazzolato e verniciato
FO mit Öl behandelt trattato con l'olio
FN gebürstet, weiß lackiert spazzolato, verniciato a bianco

Buche (Kernbuche) faggio
BU mit Wasserlack behandelt con vernice all'acqua
BN "Nuss" gebeizt und lackiert tinto noce e verniciato

Nuss (amerikanisch) noce americano
NO mit Öl behandelt trattato con l'olio

Eiche (Asteiche) rovere
EO mit Öl behandelt trattato con l'olio

Zirbe Arve cirmolo
ZR roh unbehandelt grezzo non trattato
ZO mit Öl behandelt trattato con l'olio

Griffart tipo maniglia
 Griffausfräsung bei Kommoden maniglia fresata su comò e cassettiere

	Einheitspreis prezzo unitario	kleinste Maße misure minime	maximale Größe misure massime	Beispiel esempio	Regal mit 4 Fachböden Libreria con 4 ripiani	Steckbord ripiano, fissaggio a scomparsa
Art.	3660	B-3660	B-3660	B-3660	3655	3619
BxHxT - LxAxP cm		40 x 98 x 30 cm	90 x 210 x 46 cm	85 x 150 x 35	55 x 187 x 35	127 x 4 x 23
Colli / kg	1 / 12	1 / 20	1 / 51	1 / 36	1 (2) / 45	1 / 8



	Schuhregal scarpiera	Schuhregal scarpiera	Kommode cassetiera	Regalschrank armadietto	Schreibtisch scrivania	Schreibtisch scrivania	Hocker sgabello	Spiegel specchio
Art.	3506	3507	3524	3327	3440	3444	3580	3350
BxHxT - LxAxP cm	85 x 52 x 35	127 x 52 x 35	44 x 97 x 35	85 x 97 x 35	110 x 75 x 56	110 x 75 x 56	45 x 45 x 45	50 x 75 x 2
Colli / kg	1 / 18	1 / 23	1 / 36	1 / 44	1 / 30	1 (2) / 45	1 / 8	1 / 6

HOLZART - tipologia del legno

Fichte - abete €								
Buche - faggio €								
Eiche - rovere €								
Zirbe - cirmolo €								
Nuss - noce €								

	Hängekommode comò da parete	Hängegarderobe guard. da parete	Hängegarderobe guard. da parete	Schuhschrank armadietto	Schuhschrank armadietto	Schuhschrank armadietto	Garderobenbrett pann. guardaroba	Garderobenbrett pann. guardaroba
Art.	3352	3358	3359	3361	3362	3364	3557	3567
BxHxT - LxAxP cm	85 x 62 x 35	68 x 159 x 23	85 x 159 x 23	44 x 187 x 35	68 x 187 x 35	85 x 187 x 35	85 x 18 x 7	127 x 18 x 7
Colli / kg	1 / 43	1 / 29	1 / 34	1 (2) / 48	1 (2) / 59	2 / 67	1 / 4	1 / 6

HOLZART - tipologia del legno

Fichte - abete €								
Buche - faggio €								
Eiche - rovere €								
Zirbe - cirmolo €								
Nuss - noce €								

Beispiel esempio		
Art.	3358, 3352, 3350, 3361	3524, 3507, 3567, 3362

HOLZART - tipo legname

Fichte - abete €	
Buche - faggio €	
Eiche - rovere €	
Zirbe - cirmolo €	
Nuss - noce €	

Fichte (Astfichte) abete		FR roh unbehandelt grezzo non trattato		FS gebürstet und lackiert spazzolato e verniciato		FO mit Öl behandelt trattato con l'olio		FN gebürstet, weiß lackiert spazzolato, verniciato a bianco
Buche (Kernbuche) faggio		BU mit Wasserlack behandelt con vernice all'acqua		Nuss (amerikanisch) noce americano		NO mit Öl behandelt trattato con l'olio		
Eiche (Asteiche) rovere		EO mit Öl behandelt trattato con l'olio						
Zirbe Arve cirmolo		ZR roh unbehandelt grezzo non trattato		ZO mit Öl behandelt trattato con l'olio				
		Griffart tipo maniglia		9900 Griffleiste aus Holz listello maniglia in legno		9903 Metallknopf INOX pomello metallo INOX		



<p>18° 39 mm</p> <p>r 15 mm</p> <p>Tischplatte mit abgerundeten Ecken und abgeschrägter Kante Piano con angoli arrotondati e bordo inclinato</p>	<p>Tisch - tavolo 160 x 90</p>	<p>Tisch - tavolo 200 x 90</p>	<p>Sondergrößen Preis pro m² Platte Breite: 80 bis 90 cm Länge: 120 bis 220cm</p> <p>misure extra prezzo m² largh.: 80 a 90 cm lungh.: 120 a 220 cm</p>	<p>Stuhl sedia</p>	<p>Stuhl mit Sitz gepolst. (Loden oder Kund.st.) sedia c. imbottitura (loden o tess.cliente)</p>
	<p>Art. 8516</p> <p>BxHxT - LxAxP cm 160 x 76 x 90 Colli / kg 2 / 41</p>	<p>Art. 8520</p> <p>BxHxT - LxAxP cm 200 x 76 x 90 Colli / kg 2 / 45</p>	<p>Art. 8515</p> <p>BxHxT - LxAxP cm x 76 x Colli / kg 2 / ...</p>	<p>Art. 3600</p> <p>BxHxT - LxAxP cm 40 x 90 x 50 Colli / kg 1 / 7</p>	<p>Art. 8500</p> <p>BxHxT - LxAxP cm 43 x 87 x 52 Colli / kg 1 / 7</p>

HOLZART - tipologia del legno

Fichte - abete €				
Buche - faggio €				
Eiche - rovere €				
Zirbe - cirmolo €				
Nuss - noce €				

<p>39 mm</p> <p>r 6 mm</p> <p>Tischplatte mit abgerundeten Ecken und geradem Kantenprofil Piano con angoli arrotondati e bordo dritto</p>	<p>Tisch - tavolo 160 x 90</p>	<p>Tisch - tavolo 200 x 90</p>	<p>Sondergrößen Preis pro m² Platte Breite: 80 bis 90 cm Länge: 120 bis 220cm</p> <p>misure extra prezzo m² largh.: 80 a 90 cm lungh.: 120 a 220 cm</p>	<p>Sitzpolsterung/Lfm inklusive Lodenstoff imbottitura schienale incl. tessuto Loden</p>	<p>Rückenpolst./Lfm inklusive Lodenstoff imbottitura schienale incl. tessuto Loden</p>
	<p>Art. 8616</p> <p>BxHxT - LxAxP cm 160 x 76 x 90 Colli / kg 2 / 41</p>	<p>Art. 8620</p> <p>BxHxT - LxAxP cm 200 x 76 x 90 Colli / kg 2 / 45</p>	<p>Art. 8615</p> <p>BxHxT - LxAxP cm x 76 x Colli / kg 2 / ...</p>	<p>Art. 8539</p> <p>BxHxT - LxAxP cm (100) x 3 x 50 Colli / kg 1 / 4</p>	<p>Art. 8089</p> <p>BxHxT - LxAxP cm (100) x 30 x 7 Colli / kg 1 / 5</p>

HOLZART - tipologia del legno

Fichte - abete €				
Buche - faggio €				
Eiche - rovere €				
Zirbe - cirmolo €				
Nuss - noce €				

<p>Fichte (Astfichte) abete</p> <p>F mit Wasserlack behandelt con vernice all'acqua</p>	<p>FR roh unbehandelt grezzo non trattato</p>	<p>FS gebürstet und lackiert spazzolato e verniciato</p>	<p>FO mit Öl behandelt trattato con l'olio</p>	<p>FN gebürstet, weiß lackiert spazzolato, verniciato a bianco</p>
<p>Buche (Kernbuche) faggio</p> <p>BU mit Wasserlack behandelt con vernice all'acqua</p>	<p>BN "Nuss" gebeizt und lackiert tinto noce e verniciato</p>	<p>Nuss (amerikanisch) noce americano</p>	<p>NO mit Öl behandelt trattato con l'olio</p>	
<p>Eiche (Asteiche) rovere</p> <p>EO mit Öl behandelt trattato con l'olio</p>				
<p>Zirbe Arve cirmolo</p> <p>ZR roh unbehandelt grezzo non trattato</p>	<p>ZO mit Öl behandelt trattato con l'olio</p>			

<p>39 mm</p> <p>r 6 mm</p> <p>abgerundete Ecken u. gerades Kantenprofil angoli arrotondati e bordo dritto</p>	<p>Sitzbank panca</p>	<p>Sitzbank mit Lehne panca con schienale</p>	<p>Eckbank panca ad angolo</p>	<p>Eckbank mit Lehne panca ad angolo con schienale</p>
	<p>Art. 8526</p> <p>BxHxT - LxAxP cm (120-220) x 45 x 50 Colli / kg</p>	<p>Art. 8528</p> <p>BxHxT - LxAxP cm (120-220) x 84 x 53 Colli / kg</p>	<p>Art. 8536</p> <p>BxHxT - LxAxP cm (150-220) x 45 x (150-220) Colli / kg</p>	<p>Art. 8538</p> <p>BxHxT - LxAxP cm (150-220) x 84 x (150-220) Colli / kg</p>

HOLZART - tipologia del legno

Fichte - abete €			
Buche - faggio €			
Eiche - rovere €			
Zirbe - cirmolo €			
Nuss - noce €			



<p>Tischplatte mit abgerundeten Ecken und geradem Kantenprofil Piano con angoli arrotondati e bordo dritto</p>	<p>Tisch - tavolo 160 x 90 cm</p>	<p>Tisch - tavolo 200 x 90 cm</p>	<p>Bank - Länge auf Maß Preis pro Lfm (min. 100 cm, max 220 cm) panca su misura prezzo per m.lin (min 100 cm, max 220 cm)</p>	<p>Bank mit Rückenlehne panca con schienale</p>
Art.	8075	8076	8084	8088
BxHxT - LxAxP cm	160 x 76 x 90	200 x 76 x 90	(100) x 46 x 47	(100) x 81 x 51
Colli / kg	2 / 39	2 / 47	2 / 16	2 / 24
HOLZART - tipologia del legno				
Fichte - abete €				
Buche - faggio €				
Eiche - rovere €				
Zirbe - cirmolo €				
Nuss - noce €				

<p>Tischplatte mit abgerundeten Ecken und abgschrägter Kante Piano con angoli arrotondati e bordo inclinato</p>	<p>Tisch - tavolo 160 x 90 cm</p>	<p>Tisch - tavolo 200 x 90 cm</p>	<p>Sitzpolsterung/Lfm inklusive Lodenstoff imbottitura seduta incluso tessuto Loden</p>	<p>Polsterung/Lfm inklusive Lodenstoff imbottitura schienale incluso tessuto Loden</p>
Art.	8175	8176	8086	8089
BxHxT - LxAxP cm	160 x 76 x 90	200 x 76 x 90	(100) x 3 x 47	(100) x 30 x 7
Colli / kg	2 / 41	2 / 49	1 / 4	1 / 5
HOLZART - tipologia del legno				
Fichte - abete €				
Buche - faggio €				
Eiche - rovere €				
Zirbe - cirmolo €				
Nuss - noce €				

<p>Fichte (Astfichte) abete</p> <p>F mit Wasserlack behandelt con vernice all'acqua</p>	<p>FR roh unbehandelt grezzo non trattato</p>	<p>FS gebürstet und lackiert spazzolato e verniciato</p>	<p>FO mit Öl behandelt trattato con l'olio</p>	<p>FN gebürstet, weiß lackiert spazzolato, verniciato a bianco</p>
<p>Buche (Kernbuche) faggio</p> <p>BU mit Wasserlack behandelt con vernice all'acqua</p>	<p>BN "Nuss" gebeizt und lackiert tinto noce e verniciato</p>	<p>Nuss (amerikanisch) noce americano</p> <p>NO mit Öl behandelt trattato con l'olio</p>		
<p>Eiche (Asteiche) rovere</p> <p>EO mit Öl behandelt trattato con l'olio</p>				
<p>Zirbe Arve cirmolo</p> <p>ZR roh unbehandelt grezzo non trattato</p>	<p>ZO mit Öl behandelt trattato con l'olio</p>	<p>Griffart tipo maniglia</p> <p>9900 Griffleiste aus Holz listello maniglia in legno</p>		



<p>31 mm r 6 mm abgerundete Ecken und gerades Kantenprofil angoli arrotondati e bordo dritto</p>	<p>Tisch - tavolo 140 x 80 cm</p>	<p>Tisch - tavolo 160 x 90 cm</p>	<p>Tisch - tavolo 200 x 90 cm</p>	<p>Sondergrößen Preis pro m² Platte Breite: 80 bis 100 cm Länge: 120 bis 220 cm</p> <p>misure extra prezzo m² largh.: 80 a 100 cm lungh.: 120 a 220 cm</p>
	<p>Art. 3691</p> <p>BxHxT - LxAxP cm 140 x 75 x 80 Colli / kg 2 / 28</p>	<p>Art. 3695</p> <p>BxHxT - LxAxP cm 160 x 75 x 90 Colli / kg 2 / 41</p>	<p>Art. 3697</p> <p>BxHxT - LxAxP cm 200 x 75 x 90 Colli / kg 2 / 45</p>	<p>Art. 3698</p> <p>BxHxT - LxAxP cm x 75 x Colli / kg 2 / ...</p>
HOLZART - tipologia del legno				
<p>Fichte - abete €</p> <p>Buche - faggio €</p> <p>Eiche - rovere €</p> <p>Zirbe - cirmolo €</p> <p>Nuss - noce €</p>				

<p>31 mm 83 mm r 6 mm abgerundete Ecken und gerades Kantenprofil angoli arrotondati e bordo dritto</p>	<p>Tisch - tavolo 120 x 80 cm</p>	<p>Tisch - tavolo 130 x 90 cm</p>	<p>Tisch - tavolo 160 x 90 cm</p>	<p>Sondergrößen Preis pro m² Platte Breite: 80 bis 100 cm Länge: 120 bis 220 cm</p> <p>misure extra prezzo m² largh.: 80 a 100 cm lungh.: 120 a 220 cm</p>	<p>Unterteil m. Schubl. base con cassetto</p>	<p>Steckbord ripiano, fissaggio a scomparsa</p>
	<p>Art. 3590</p> <p>BxHxT - LxAxP cm 120 x 75 x 80 Colli / kg 2 / 28</p>	<p>Art. 3594</p> <p>BxHxT - LxAxP cm 130 x 75 x 90 Colli / kg 2 / 37</p>	<p>Art. 3595</p> <p>BxHxT - LxAxP cm 160 x 75 x 90 Colli / kg 2 / 41</p>	<p>Art. 3598</p> <p>BxHxT - LxAxP cm x 75 x Colli / kg 2 / ...</p>	<p>Art. 3504</p> <p>BxHxT - LxAxP cm 127 x 31 x 56 Colli / kg 1 / 30</p>	<p>Art. 3619</p> <p>BxHxT - LxAxP cm 127 x 4 x 23 Colli / kg 1 / 8</p>
HOLZART - tipologia del legno						
<p>Fichte - abete €</p> <p>Buche - faggio €</p> <p>Eiche - rovere €</p> <p>Zirbe - cirmolo €</p> <p>Nuss - noce €</p>						

<p>Fichte (Astfichte) abete</p> <p>F mit Wasserlack behandelt con vernice all'acqua</p>	<p>FR roh unbehandelt grezzo non trattato</p>	<p>FS gebürstet und lackiert spazzolato e verniciato</p>	<p>FO mit Öl behandelt trattato con l'olio</p>	<p>FN gebürstet, weiß lackiert spazzolato, verniciato a bianco</p>
<p>Buche (Kernbuche) faggio</p> <p>BU mit Wasserlack behandelt con vernice all'acqua</p>	<p>BN "Nuss" gebeizt und lackiert tinto noce e verniciato</p>	<p>Nuss (amerikanisch) noce americano</p>	<p>NO mit Öl behandelt trattato con l'olio</p>	
<p>Eiche (Asteiche) rovere</p> <p>EO mit Öl behandelt trattato con l'olio</p>				
<p>Zirbe Arve cirmolo</p> <p>ZR roh unbehandelt grezzo non trattato</p>	<p>ZO mit Öl behandelt trattato con l'olio</p>	<p>Griffart tipo maniglia</p>	<p>9900 Griffleiste aus Holz listello maniglia in legno</p>	<p>9903 Metallknopf INOX pomello metallo INOX</p>

<p>Sitzbank mit Lehne - Länge auf Maß Preis pro Lfm (min. 100cm, max 220cm)</p>	<p>Rückenpolst./Lfm inklusive Lodenstoff imbottitura schienale incl. tessuto Loden</p>	<p>Sitzbank auf Maß panca su misura prezzo per m.lin (min. 100cm, max 220cm)</p>	<p>Rückenlehne schienale prezzo per m.lin (min. 100cm, max 220cm)</p>	<p>Hocker sgabello</p>	<p>Stuhl sedia</p>
HOLZART - tipologia del legno					
<p>Fichte - abete €</p> <p>Buche - faggio €</p> <p>Eiche - rovere €</p> <p>Zirbe - cirmolo €</p> <p>Nuss - noce €</p>					



<p>Tischplatte mit geradem Kantenprofil Piano con bordo dritto</p>	<p>Ausziehtisch tavolo con piano estraibile</p>	<p>Tisch - tavolo 160 x 90 cm</p>	<p>Tisch - tavolo 200 x 90 cm</p>	<p>Stuhl sedia</p>	<p>Stuhl mit Sitz gepolstert (Loden oder Kundenstoff) sedia con sed. imbottita (loden o tessuto cliente)</p>
Art.	3601	3602	3603	3600	8500
BxHxT - LxAxP cm	160/220 x 75 x 90	160 x 75 x 90	200 x 75 x 90	40 x 90 x 50	43 x 87 x 52
Colli / kg	2 / 61	2 / 42	2 / 50	1 / 7	1 / 7
HOLZART - tipologia del legno					
Fichte - abete €					
Buche - faggio €					
Eiche - rovere €					
Zirbe - cirmolo €					
Nuss - noce €					

<p>Fichte (Astfichte) abete</p> <p>F mit Wasserlack behandelt con vernice all'acqua</p>	<p>FR roh unbehandelt grezzo non trattato</p>	<p>FS gebürstet und lackiert spazzolato e verniciato</p>	<p>FO mit Öl behandelt trattato con l'olio</p>	<p>FN gebürstet, weiß lackiert spazzolato, verniciato a bianco</p>
<p>Buche (Kernbuche) faggio</p> <p>BU mit Wasserlack behandelt con vernice all'acqua</p>	<p>BN "Nuss" gebeizt und lackiert tinto noce e verniciato</p>	<p>Nuss (amerikanisch) noce americano</p>	<p>NO mit Öl behandelt trattato con l'olio</p>	
<p>Eiche (Asteiche) rovere</p> <p>EO mit Öl behandelt trattato con l'olio</p>				
<p>Zirbe Arve cirmolo</p> <p>ZR roh unbehandelt grezzo non trattato</p>	<p>ZO mit Öl behandelt trattato con l'olio</p>			

GARDENA GA33 Seiten: 08-11 pagine:

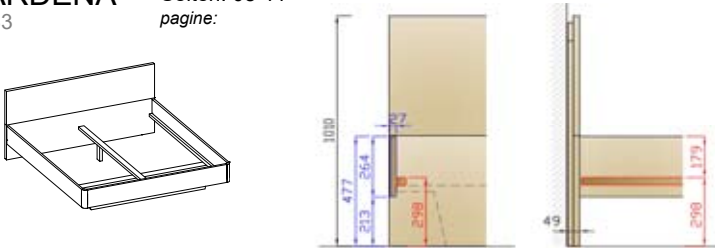

	mm
Höhe Kopfteil - <i>altezza testata</i>	1010
Höhe Bettrahmen (Oberkante) - <i>altezza giroletto</i>	477
Höhe Bettseiten - <i>altezza sponde</i>	264
Einlegetiefe Bettseiten - <i>altezza interna sponde</i>	179
Höhe Auflageleisten - <i>altezza listelli d'appoggio rete</i>	298
Liegehöhe (Lattenrost und Matratze ca. 25 cm)	550
<i>altezza totale (con rete e materasso da 25 cm)</i>	
Materialstärken - spessori	
Kopfteil inkl. Montagerahmen - <i>testata con supporto</i>	49
Bettseiten, Kopf- und Fußteil - <i>sponde, testata e pediera</i>	27

NATURA NA34 Seiten: 32-33 pagine:

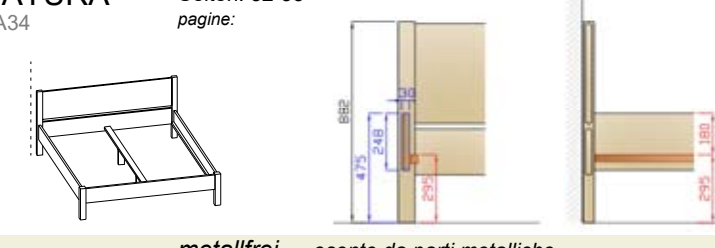

	mm
Höhe Kopfteil - <i>altezza testata</i>	882
Höhe Bettrahmen (Oberkante) - <i>altezza giroletto</i>	475
Höhe Bettseiten - <i>altezza sponde</i>	248
Einlegetiefe Bettseiten - <i>altezza interna sponde</i>	180
Höhe Auflageleisten - <i>altezza listelli d'appoggio rete</i>	295
Liegehöhe (Lattenrost und Matratze ca. 25 cm)	550
<i>altezza totale (con rete e materasso da 25 cm)</i>	
Materialstärken - spessori	
Bettsteher Fußteil - <i>gambe pediera</i>	69 x 57
Bettseiten - <i>sponde</i>	31
Kopf- und Fußteil - <i>testata e pediera</i>	31

metallfrei - esente da parti metalliche

ELBA EL40 Seiten: 12-13 pagine:

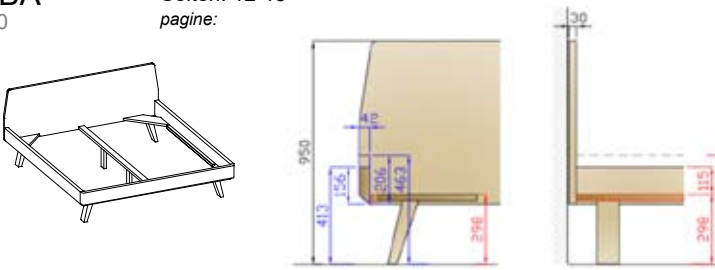

	mm
Höhe Kopfteil - <i>altezza testata</i>	950
Höhe Bettrahmen (Oberkante) - <i>altezza giroletto</i>	413 / 463
Höhe Bettseiten - <i>altezza sponde</i>	156 / 206
Einlegetiefe Bettseiten - <i>altezza interna sponde</i>	115 / 165
Höhe Auflageleisten - <i>altezza listelli d'appoggio rete</i>	298
Liegehöhe (Lattenrost und Matratze ca. 25 cm)	550
<i>altezza totale (con rete e materasso da 25 cm)</i>	
Materialstärken - spessori	
Kopfteil - <i>testata</i>	30
Bettseiten und Fußteil - <i>sponde e pediera</i>	42

ALPINA AL36 Seiten: 38-39 pagine:

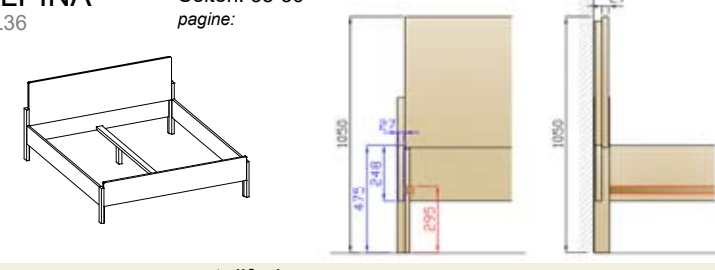

	mm
Höhe Kopfteil - <i>altezza testata</i>	1050
Höhe Fußteil - <i>altezza pediera</i>	475 / 550
Höhe Bettrahmen (Oberkante) - <i>altezza giroletto</i>	475
Höhe Bettseiten - <i>altezza sponde</i>	248
Einlegetiefe Bettseiten - <i>altezza interna sponde</i>	180
Höhe Auflageleisten - <i>altezza listelli d'appoggio rete</i>	295
Liegehöhe (Lattenrost und Matratze ca. 25 cm)	550
<i>altezza totale (con rete e materasso da 25 cm)</i>	
Materialstärken - spessori	
Kopfteil und Bettseiten - <i>testiera e sponde</i>	27 (61)
Fußteil - <i>pediera</i>	31

metallfrei - esente da parti metalliche

CORTINA CO31 Seiten: 14-19 pagine:

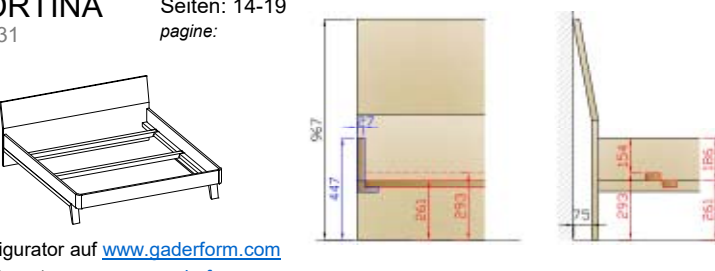

	mm
Höhe Kopfteil - <i>altezza testata</i>	967
Höhe Bettrahmen (Oberkante) - <i>altezza giroletto</i>	447
Höhe Bettseiten - <i>altezza sponde</i>	186
Einlegetiefe Bettseiten - <i>altezza interna sponde</i>	186 / 154
Höhe Auflageleisten - <i>altezza listelli d'appoggio rete</i>	261 / 293
Liegehöhe (Lattenrost und Matratze ca. 25 cm)	550
<i>altezza totale (con rete e materasso da 25 cm)</i>	
Materialstärken - spessori	
Auflageleisten und Füße - <i>listelli supporto e gambe</i>	52
Bettseiten, Kopf- und Fußteil - <i>sponde, testata e pediera</i>	27

Konfigurator auf www.gaderform.com
configuratore su www.gaderform.com

FANES FA38 Seiten: 40-41 pagine:

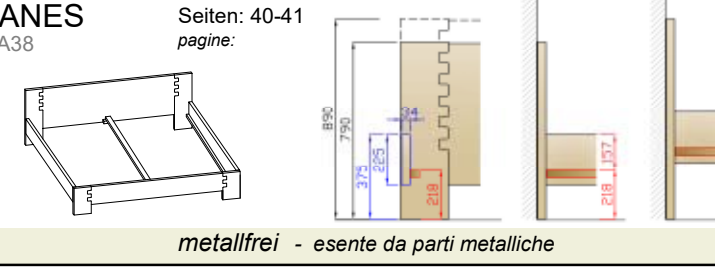

	mm
Höhe Kopfteil - <i>altezza testata</i>	790 / 890
Höhe Bettrahmen (Oberkante) - <i>altezza giroletto</i>	380 / 480
Höhe Bettseiten - <i>altezza sponde</i>	225
Einlegetiefe Bettseiten - <i>altezza interna sponde</i>	157
Höhe Auflageleisten - <i>altezza listelli d'appoggio rete</i>	218 / 318
Liegehöhe (Lattenrost und Matratze ca. 25 cm)	470 / 570
<i>altezza totale (con rete e materasso da 25 cm)</i>	
Materialstärken - spessori	
Kopf- und Fußteil, Bettseiten - <i>testata, pediera e sponde</i>	35

metallfrei - esente da parti metalliche

AMSTERDAM AM21 AM17 Seiten: 20-25 pagine:

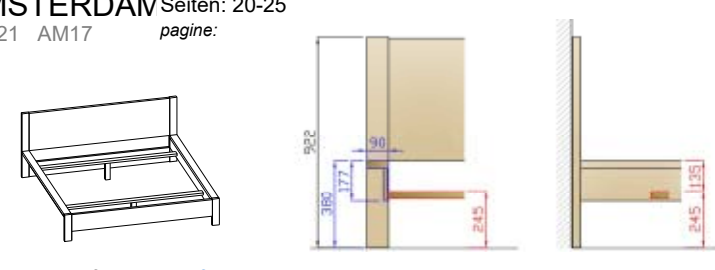

	mm
Höhe Kopfteil - <i>altezza testata</i>	922
Höhe Bettrahmen (Oberkante) - <i>altezza giroletto</i>	380
Höhe Bettseiten - <i>altezza sponde</i>	177
Einlegetiefe Bettseiten - <i>altezza interna sponde</i>	135
Höhe Auflageleisten - <i>altezza listelli d'appoggio rete</i>	245
Liegehöhe (Lattenrost und Matratze ca. 25 cm)	500
<i>altezza totale (con rete e materasso da 25 cm)</i>	
Materialstärken - spessori	
Seitenleisten und Bettsteher - <i>listelli sponde e gambe</i>	35
Fußteil - <i>pediera</i>	31

Konfigurator auf www.gaderform.com
configuratore su www.gaderform.com

INNSBRUCK IB29 Seiten: 42-43 pagine:

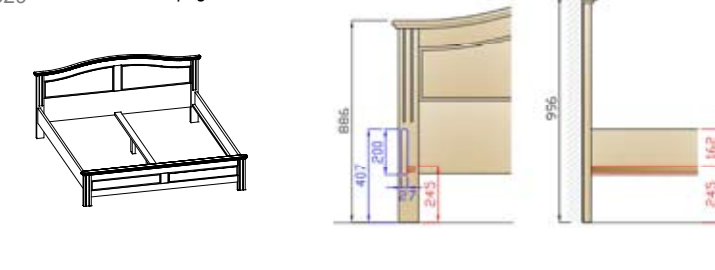

	mm
Höhe Kopfteil - <i>altezza testata</i>	886 / 996
Höhe Fußteil - <i>altezza pediera</i>	455 / 551
Höhe Bettrahmen (Oberkante) - <i>altezza giroletto</i>	407
Höhe Bettseiten - <i>altezza sponde</i>	200
Einlegetiefe Bettseiten - <i>altezza interna sponde</i>	162
Höhe Auflageleisten - <i>altezza listelli d'appoggio rete</i>	245
Liegehöhe (Lattenrost und Matratze ca. 25 cm)	500
<i>altezza totale (con rete e materasso da 25 cm)</i>	
Materialstärken - spessori	
Bettsteher, Kranzabschluss - <i>gambe e cornici</i>	35
Bettseiten - <i>sponde</i>	27

NEW YORK NY19 Seiten: 26-29 pagine:

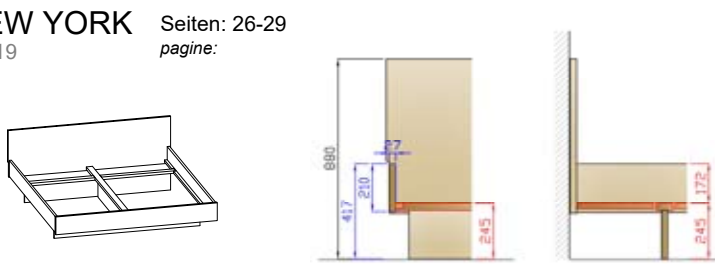

	mm
Höhe Kopfteil - <i>altezza testata</i>	880
Höhe Bettrahmen (Oberkante) - <i>altezza giroletto</i>	417
Höhe Bettseiten - <i>altezza sponde</i>	200 (274)
Einlegetiefe Bettseiten - <i>altezza interna sponde</i>	172
Höhe Auflageleisten - <i>altezza listelli d'appoggio rete</i>	245
Liegehöhe (Lattenrost und Matratze ca. 25 cm)	500
<i>altezza totale (con rete e materasso da 25 cm)</i>	
Materialstärken - spessori	
Kopf- und Fußteil, Bettseiten - <i>testata, pediera e sponde</i>	27

LUGANO LU12 Seiten: 46-47 pagine:

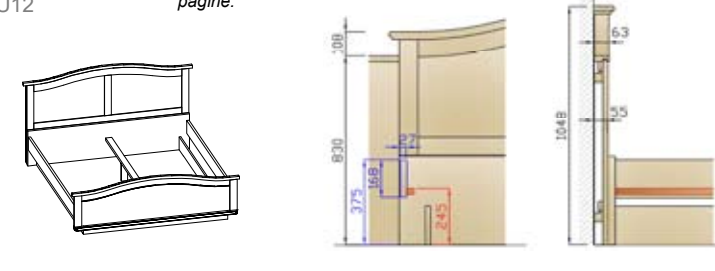

	mm
Höhe Kopftäfelung - <i>altezza testata</i>	1048
Höhe Fußteil - <i>altezza pediera</i>	659
Höhe Bettrahmen (Oberkante) - <i>altezza giroletto</i>	375
Höhe Bettseiten - <i>altezza sponde</i>	168
Einlegetiefe Bettseiten - <i>altezza interna sponde</i>	130
Höhe Auflageleisten - <i>altezza listelli d'appoggio rete</i>	245
Liegehöhe (Lattenrost und Matratze ca. 25 cm)	500
<i>altezza totale (con rete e materasso da 25 cm)</i>	
Materialstärken - spessori	
Kranzabschluss Kopf-, Fußteil - <i>cornice testata e pediera</i>	35
Bettseiten - <i>sponde</i>	27

GINEVRA GI15 Seiten: 30-31 pagine:

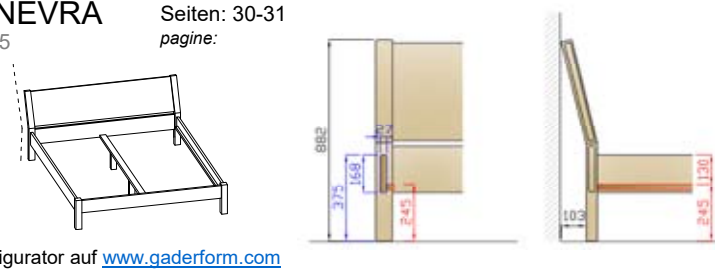

	mm
Höhe Kopfteil - <i>altezza testata</i>	882
Höhe Bettrahmen (Oberkante) - <i>altezza giroletto</i>	375
Höhe Bettseiten - <i>altezza sponde</i>	168
Einlegetiefe Bettseiten - <i>altezza interna sponde</i>	130
Höhe Auflageleisten - <i>altezza listelli d'appoggio rete</i>	245
Liegehöhe (Lattenrost und Matratze ca. 25 cm)	500
<i>altezza totale (con rete e materasso da 25 cm)</i>	
Materialstärken - spessori	
Bettsteher Fußteil - <i>gambe pediera</i>	69 x 57
Bettseiten, Kopf- und Fußteil - <i>sponde, testata e pediera</i>	27

Konfigurator auf www.gaderform.com
configuratore su www.gaderform.com

CASTELLO CA18 Seiten: 48-49 pagine:

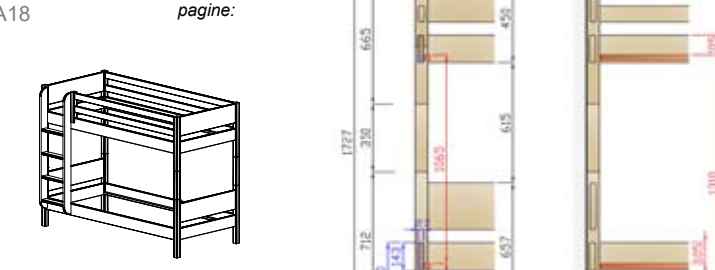

	mm
Höhe Kopfteil gesamt - <i>altezza testata totale</i>	1727
Höhe Kopfteil unten - <i>altezza testata sotto</i>	712
Höhe Kopfteil oben - <i>altezza testata sopra</i>	665
Höhe Bettrahmen (Oberkante) - <i>altezza giroletto</i>	350
Höhe Bettseiten - <i>altezza sponde</i>	143
Einlegetiefe Bettseiten - <i>altezza interna sponde</i>	105
Höhe Auflageleisten - <i>altezza listelli d'appoggio rete</i>	245
Liegehöhe (Lattenrost und Matratze ca. 25 cm)	500
<i>altezza totale (con rete e materasso da 25 cm)</i>	
Materialstärken - spessori	
Bettsteher Fußteil - <i>gambe pediera</i>	56 x 56
Bettseiten, Kopf- und Fußteil - <i>sponde, testata e pediera</i>	27

CORTINA CO31 Seiten - pagine: 52-53

System - Drehtürenschränk
armadi componibili con ante battenti

Höhe - altezza 226 cm

Konfigurator auf www.gaderform.com
configuratore su www.gaderform.com

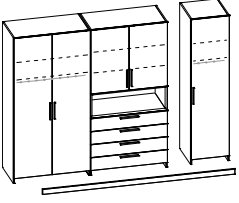

Holzgriff
maniglia in legno
250 x 13 x 28 mm



Beschläge - ferramenta
Scharnier mit integrierter Türbremse
cerniera con ammortizzatore integrato

Vollauszüge mit integrierter Einzugsdämpfung
estrazione totale con ammortizzatore integrato

Materialstärken - spessori

Türen (innen + außen 5 mm Sägefurnier und Kern in Fichte) ante (strati esterni da 5 mm con strato centrale in abete)	24
Seiten und Böden - fianchi e piani	18
Rückwand (Sperrholz 5-Schichtplatte gebeizt/lackiert) schienale (pannello multistrato - tinto/verniciato)	8

GINEVRA GI15 AMSTERDAM AM17 Seiten - pagine: 28-29
Seiten - pagine: 20-21

Drehtürenschränk
armadio con ante battenti

Höhe - altezza 206 cm (GI15)
Höhe - altezza 208 cm (AM17)

Konfigurator auf www.gaderform.com
configuratore su www.gaderform.com



Griffkart
tipo maniglia

INOX



Holzgriff
maniglia in legno



Beschläge - ferramenta
Scharnier mit integrierter Türbremse
cerniera con ammortizzatore integrato

Materialstärken - spessori

Türfriese - cornice ante	24
Türfüllungen - pannelli interni ante	14
Kranzabschluss (AM17) - cornice (AM17)	26
Aufdoppelung Seiten - listello anteriore fianchi	26 / 32
Seiten und Böden - fianchi e piani	18
Rückwand (Sperrholz 5-Schichtplatte gebeizt/lackiert) schienale (pannello multistrato - tinto/verniciato)	8

GARDA GA36 Seiten - pagine: 54-55

offener Garderobenschrank
armadi guardaroba a giorno

Höhe - altezza 226 cm

Konfigurator auf www.gaderform.com
configuratore su www.gaderform.com



Griffausfräsung
maniglia fresata



Beschläge - ferramenta
Vollauszüge mit integrierter Einzugsdämpfung
estrazione totale con ammortizzatore integrato

Materialstärken - spessori

Seiten und Böden - fianchi e piani	20
Rückwand (Sperrholz 5-Schichtplatte gebeizt/lackiert) schienale (pannello multistrato - tinto/verniciato)	8

MERANO ME06 Seiten - pagine: 60-61

System - Drehtürenschränk
armadi componibili con ante battenti

Höhen - altezze 188 / 238 cm

Konfigurator auf www.gaderform.com
configuratore su www.gaderform.com

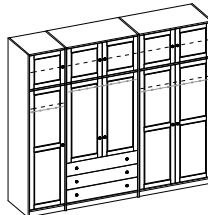

Griffknopf
pomello

Fichte, Zirbe
abete, cirmolo



INOX



Beschläge - ferramenta
Scharnier mit integrierter Türbremse
cerniera con ammortizzatore integrato

Vollauszüge mit integrierter Einzugsdämpfung
estrazione totale con ammortizzatore integrato

Materialstärken - spessori

Türen und Seiten - ante e fianchi	20
Böden - piani	18
Rückwand (Sperrholz 5-Schichtplatte gebeizt/lackiert) schienale (pannello multistrato - tinto/verniciato)	8

AMSTERDAM AM21 Seiten - pagine: 20-21

System - Drehtürenschränk
armadi componibili con ante battenti

Höhe - altezza 231 cm

Konfigurator auf www.gaderform.com
configuratore su www.gaderform.com

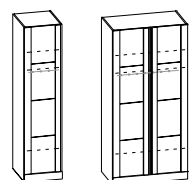

Griffausfräsung
maniglia fresata



Beschläge - ferramenta
Scharnier mit integrierter Türbremse
cerniera con ammortizzatore integrato

Vollauszüge mit integrierter Einzugsdämpfung
estrazione totale con ammortizzatore integrato

Materialstärken - spessori

Türfriese - laterali ante	27
Türfüllungen - pannelli centrali ante	18
Seiten und Böden - fianchi e piani	18
Rückwand (Sperrholz 5-Schichtplatte gebeizt/lackiert) schienale (pannello multistrato - tinto/verniciato)	8

INNSBRUCK IB29 Seiten - pagine: 40-41

System - Drehtürenschränk
armadi componibili con ante battenti

Höhe - altezza 226 + 5 cm

Konfigurator auf www.gaderform.com
configuratore su www.gaderform.com



Griffknopf
pomello



Beschläge - ferramenta
Scharnier mit integrierter Türbremse
cerniera con ammortizzatore integrato

Vollauszüge mit integrierter Einzugsdämpfung
estrazione totale con ammortizzatore integrato

Materialstärken - spessori

Kranzabschluss - cornice superiore	57
Türen, Schubladvorderstücke - ante e frontali cassetti	24
Seiten und Böden - fianchi e piani	18
Rückwand (Sperrholz 5-Schichtplatte gebeizt/lackiert) schienale (pannello multistrato - tinto/verniciato)	8

AMSTERDAM AM22 Seiten - pagine: 56-57

Schiebetürenschränk
armadio con ante scorrevoli

Höhe - altezza 180-237 cm

Konfigurator auf www.gaderform.com
configuratore su www.gaderform.com

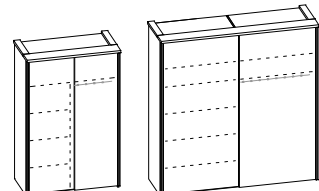

Griffleiste
listello maniglia



Beschläge - ferramenta
Schwebetürenbeschlag
dispositivo superiore per ante scorrevoli

Materialstärken - spessori

Kranzabschluss - cornice	35
Schiebetüren - ante scorrevoli	30
Griffleiste - listello maniglia	27
Seiten und Böden - fianchi e piani	18
Rückwand (Sperrholz 5-Schichtplatte gebeizt/lackiert) schienale (pannello multistrato - tinto/verniciato)	8

NIZZA NI10 Seiten - pagine: 42-43

Drehtürenschränk
armadio con ante battenti

Höhe - altezza 206 cm

Konfigurator auf www.gaderform.com
configuratore su www.gaderform.com



Griffknopf
pomello

Fichte, Zirbe
abete, cirmolo



INOX



Beschläge - ferramenta
Scharnier mit integrierter Türbremse
cerniera con ammortizzatore integrato

Materialstärken - spessori

Türen - ante	20
Aufdoppelung Seiten - listello anteriore fianchi	32
Seiten und Böden - fianchi e piani	18
Rückwand (Sperrholz 5-Schichtplatte gebeizt/lackiert) schienale (pannello multistrato - tinto/verniciato)	8

NEW YORK NY19 Seiten - pagine: 28-29

System - Drehtürenschränk
armadi componibili con ante battenti

Höhe - altezza 231 cm

Konfigurator auf www.gaderform.com
configuratore su www.gaderform.com

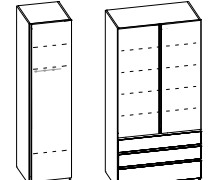

Griffausfräsung
maniglia fresata



Beschläge - ferramenta
Scharnier mit integrierter Türbremse
cerniera con ammortizzatore integrato

Vollauszüge mit integrierter Einzugsdämpfung
estrazione totale con ammortizzatore integrato

Materialstärken - spessori

Türen (innen + außen 5 mm Sägefurnier und Kern in Fichte) ante (strati esterni da 5 mm con strato centrale in abete)	24
Seiten und Böden - fianchi e piani	18
Rückwand (Sperrholz 5-Schichtplatte gebeizt/lackiert) schienale (pannello multistrato - tinto/verniciato)	8

inklusive Sockelfüße zur Höhenverstellung
incluso piedini regolatori d'altezza

LUGANO LU12 Seiten - pagine: 44-45

Drehtürenschränk
armadio con ante battenti

Höhe - altezza 210 cm

Konfigurator auf www.gaderform.com
configuratore su www.gaderform.com

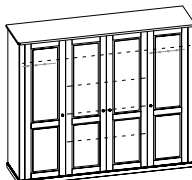

Griffknopf
pomello

Fichte, Zirbe
abete, cirmolo



INOX



Beschläge - ferramenta
Scharnier mit integrierter Türbremse
cerniera con ammortizzatore integrato

Materialstärken - spessori

Kranzabschluss - cornice superiore	44
Türen - ante	24
Seiten und Böden - fianchi e piani	18
Rückwand (Sperrholz 5-Schichtplatte gebeizt/lackiert) schienale (pannello multistrato - tinto/verniciato)	8